



# Standard Specification for Driven Fasteners: Nails, Spikes, and Staples<sup>1</sup>

This standard is issued under the fixed designation F 1667; the number immediately following the designation indicates the year of original adoption or, in the case of revision, the year of last revision. A number in parentheses indicates the year of last approval. A superscript epsilon (ε) indicates an editorial change since the last revision or reapproval.

*This standard has been approved for use by agencies of the Department of Defense. The Commercial and Government Entity (Cage) Code for ASTM: 81346.*

## 1. Scope\*

1.1 This specification covers nails, spikes, staples, and other driven fasteners, as listed in **Table 1**.

NOTE 1—Fastener ductility information is presented in **Table 2** and dimensional information in **Tables 3-64**.

1.2 Fasteners described in this specification are driven by hand tool, power tool, or mechanical device in single or multiple strikes and are positioned by hand, tool, or machine.

1.3 The values stated in inch-pound units are to be regarded as the standard.

1.4 *This standard does not purport to address all of the safety concerns, if any, associated with its use. It is the responsibility of the user of this standard to establish appropriate safety and health practices and determine the applicability of regulatory limitations prior to use.*

## 2. Referenced Documents

2.1 *ASTM Standards:*<sup>2</sup>

**A 153/A 153M** Specification for Zinc Coating (Hot-Dip) on Iron and Steel Hardware

**A 510M** Specification for General Requirements for Wire Rods and Coarse Round Wire, Carbon Steel [Metric]

**A 641/A 641M** Specification for Zinc-Coated (Galvanized) Carbon Steel Wire

**B 695** Specification for Coatings of Zinc Mechanically Deposited on Iron and Steel

**F 547** Terminology of Nails for Use with Wood and Wood-Base Materials

**F 592** Terminology of Collated and Cohered Fasteners and Their Application Tools

**F 680** Test Methods for Nails

**F 1575** Test Method for Determining Bending Yield Moment of Nails

## 3. Terminology

3.1 *Definitions*—The definitions used in this specification are those of common commercial acceptance and usage and also appear in Terminologies **F 547** and **F 592**.

## 4. Classification

4.1 The fasteners and their **Table 1** classification are identified as follows:

NOTE 2—The identification of fasteners, classified by style and type (alpha indicators) followed by a dash number (numerical code) based on **Tables 3-64**, identifies dimensions specifically and establishes a PIN (part identifying number) system when preceded by the F 1667 ASTM designation of this specification. For example:

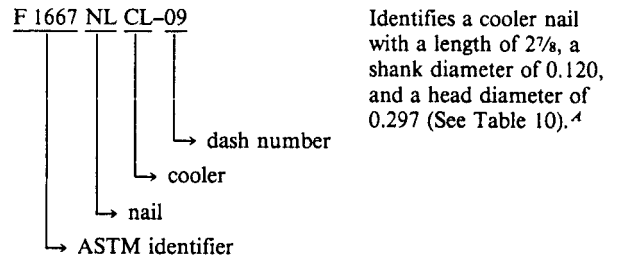

<sup>4</sup> All dimensions are given in inches.

4.2 The trade designation, S, pennyweight, used in commercial practice is referenced in **Tables 3-64** wherever it applies.

## 5. Ordering Information

5.1 Orders for driven fasteners under this specification shall include the following information:

5.1.1 Quantity or weight;

5.1.2 Part identifying number (PIN) or product description (see **4.1** and appropriate table);

<sup>1</sup> This specification is under the jurisdiction of ASTM Committee F16 on Fasteners and is the direct responsibility of Subcommittee F16.05 on Driven and Other Fasteners.

Current edition approved Nov. 15, 2005. Published January 2006. Originally approved in 1995. Last previous edition approved in 2003 as F 1667 – 03.

<sup>2</sup> For referenced ASTM standards, visit the ASTM website, www.astm.org, or contact ASTM Customer Service at service@astm.org. For *Annual Book of ASTM Standards* volume information, refer to the standard's Document Summary page on the ASTM website.

\*A Summary of Changes section appears at the end of this standard.

**TABLE 1 Classification and Identification Index**

Type	Style	Style Identification	Table	
I—Nails (NL)	1. Brads	BR	3	
	2. Barrel	BL	4	
	3. Boat	BTH/BTL	5	
	4. Box A	BXA	6	
		Box B	BXB	7
	5. Broom	BM	8	
	6. Casing	CN	9	
	7. Cooler	CL	10	
	8. Sinkers	SK	11	
	9. Corker	CK	12	
	10. Common	CMA	13	
		Common	CMC	14
		Common	CMS	15
		Common	CMM	16
	11. Concrete	CTS/CTM	17	
	12. Double-headed	DH	18	
	13. Fine	FN	19	
	14. Finishing	FH	20	
	15. Flooring	FL	21	
	16. Lath	LHF	22	
		LHH	23	
	17. Masonry	MR/MRH	24	
	18. Pallet	PL	25	
	19. Gypsum wallboard	GWS	26	
		GWM	27	
	20. Roofing	RFA	28	
		RFS	29	
		RFC	30	
		RFL	31	
		RFR	32	
RFD		33		
RFNS/RFND		34		
21. Shingle		SHAD/SHAS	35	
	SHSS/SHNSB	36		
22. Siding	SDF/SDC/SDK	37		
23. Slating	SLA/SLC/SLS	38		
24. Rubber heel	RH	39		
25. Underlayment	UL	40		
26. Square-barbed	SB	41		
27. Masonry drive	MD	42		
28. Escutcheon	ES	43		
29. Glulam rivet	GR	44		
II—Cut nails (CN)	30. Post frame	PF	45	
		Common	CM	46
	2. Basket	BK	47	
	3. Clout	CL	48	
	4. Trunk	TR	49	
	5. Cobblers	CB	50	
	6. Extra-iron clinching	EC	51	
III—Spikes (SP)	7. Hob	HB	52	
	1. Common	CM	53	
	2. Gutter	GRF/GRO	54	
	3. Round	RDC/RDF	55	
	4. Barge and boat	BB	56	
IV—Staples (ST)	1. Fence	FN	57	
	2. Poultry netting	PN	58	
		Flat top crown	FC	59
	Flat top crown	FCC	60	
	4. Round or V crown	RC	61	
	5. Preformed	PC	62	
	6. Electrical	RE	63	
7. Preformed hoop	PH	64		

5.1.3 Special material requirements, if specified, including coatings or finishes;

5.1.4 ASTM designation;

5.1.5 Packaging requirements;

5.1.6 A producer's or supplier's certification that the material and the finished fastener are in compliance with this specification, furnished only when specified in the purchase order;

**TABLE 2 Bend Angles for Fasteners Using the Test Methods F 680 Bend Test**

Fastener Material	Bend Angle, °
1. Steel wire: (low-carbon, medium-low carbon, medium-carbon) (unhardened)	180
2. Stainless steel wire	180
3. Hardened steel fasteners	20
4. Sheet steel for cut nails, Type II, and cut spikes, Type III	90
5. Copper (min 98 %)	180
6. Copper clad wire (min 20 %)	180
7. Aluminum alloy wire	90
8. Brass wire	180

5.1.7 Supplementary requirements, if any; and

5.1.8 Any additions agreed upon between the purchaser and the supplier.

## 6. Material Requirements

6.1 Steel wire used in the manufacture of driven fasteners shall be of low carbon, medium-low carbon, or medium-high carbon.

6.2 Stainless steel wire used in the manufacture of driven fasteners shall be of Types 302, 304, 305, or 316.

6.3 Carbon steel wire for the manufacture of hardened steel nails shall be suitable for heat treatment to a minimum hardness of 37 HRC.

6.4 Sheet steel used in the manufacture of cut nails (Type II) and cut spikes (Type III) shall be a medium-carbon sheet steel.

6.5 Copper used in the manufacture of driven fasteners shall contain a minimum of 98 % pure copper.

6.6 Copper-clad steel wire used in the manufacture of driven fasteners shall contain not less than 20 % copper by weight. The average thickness of copper on the steel wire shall be not less than 10 % of the radius of the clad wire; the minimum thickness of copper on the steel wire shall be not less than 8 % of the radius of the clad wire.

6.7 Aluminum alloy wire used in the manufacture of fasteners shall conform to Alloy 2024, 5056, 6061, or 6110 and have a minimum ultimate tensile strength of 60 000 psi.

NOTE 3—Smooth shank nails are sometimes chemically treated to remove grease, oil, and foreign matter and to roughen the surface microscopically. Mechanically deformed nails are sometimes cleaned to remove grease and foreign matter.

6.8 Brass wire used in the manufacture of fasteners shall be of good commercial quality suitable for the purpose.

## 7. Physical Properties

7.1 *Ductility*—The fasteners shall be sufficiently ductile to withstand cold bending without fracture, as specified in [Table 2](#) for various materials used in the manufacture of fasteners utilizing the conventional bend test described in Test Methods [F 680](#). Mandrel diameter used in this test shall not exceed nail/wire diameter. The cold bend test shall not apply to unhardened nails with deformed shanks.

7.2 *Tensile Strength*—Finished driven fasteners are not normally subject to tension testing. However, the wire or sheet used to manufacture the fastener is tested as required for control in the production process during manufacture.

## 8. Dimensions and Tolerances

8.1 Nominal dimensions of nails and spikes shall be as shown in [Tables 3-56](#). The following dimensional designations shall apply:

*S* = trade designation (reference in penny weight),  
*L* = length, in.,  
*H* = head diameter or width, in.,  
*D* = shank diameter, in.,  
*B* = head separation, in. ([Table 18](#)), and  
*No./lb* = approximate count per pound.

8.1.1 The lengths, *L*, of nails and spikes with flat heads or parallel shoulders under the head shall be measured from under the head or shoulder to the tip of the point. All other nails and spikes shall be measured overall.

8.1.2 The diameter, *D*, of smooth shank nails and spikes shall be measured away from the gripper marks. The diameter, *D*, of formed or deformed shanks shall be measured before deformation, or, if specified, the thread crest diameter after deformation, or both. All diameter dimensions shall be taken prior to the application of or after the removal of any coatings or finish.

8.2 *Tolerances on Nominal Dimensions for Nails and Spikes:*

8.2.1 Length tolerances shall be  $\pm 1/32$  in. for lengths up to and including 1 in.;  $\pm 1/16$  in. for lengths over 1 in., up to and including  $2\frac{1}{2}$  in.;  $\pm 3/32$  for lengths over  $2\frac{1}{2}$  in., up to and including 7 in.; and  $\pm 1/8$  in. for all lengths over 7 in.

8.2.2 Shank diameter tolerances shall be  $\pm 0.002$  in. for diameters smaller than 0.076 in. and  $\pm 0.004$  in. for diameters 0.076 in. and larger.

8.2.3 *Head Diameter Tolerances:*

8.2.3.1 *Hand Driven*—Tolerances on head diameters of roofing nails shall be +0, -10 % of the nominal head diameter (the mean of two readings 90° apart). For other brads, nails, and spikes, the tolerance shall be  $\pm 10$  % of the nominal head diameter (individual measurement). The difference in diameter across the long axis of a roofing nail shall not exceed that across the short axis by more than 20 %. For other brads, nails, and spikes, the difference in diameter across the long axis shall not exceed that across the short axis by more than 10 %. A fillet shall be provided under the head if not otherwise specified.

8.2.3.2 *Power Driven*—Tolerances on head diameters of power-driven nails shall comply with the manufacturer's specifications and shall be suitable for use in the make and model of the tool specified.

8.3 Nominal dimensions of staples shall be as shown in [Tables 57-64](#), and the following dimensional designations shall apply:

8.3.1 *Hand Tool-Driven Nominal Dimensions:*

*L* = leg length, inside, in.,  
*D* = round leg diameter, in.,  
*C* = crown width, inside, in., and  
*No./lb* = approximate count per pound.

8.3.2 *Power Tool-Driven Nominal Dimensions:*

*D* = round leg diameter, in.,  
*L* = leg length, outside, in.,  
*T* = leg thickness, in. (see [Tables 59 and 60](#)),  
*W* = leg width, in. (see [Tables 59 and 60](#)),  
*C* = crown width, outside, in., and  
*G* = steel wire gage.

8.4 *Tolerances on Nominal Dimensions for Staples:*

8.4.1 Leg length, *L*, tolerances shall be  $+1/32$ ,  $-1/64$  in. for both hand tool-driven and power tool-driven staples.

8.4.2 Diameter tolerances for hand tool-driven round staples shall be  $\pm 0.002$  in. for diameters smaller than 0.076 in. and  $\pm 0.004$  in. for diameters 0.076 in. and larger.

8.4.3 Thickness and width tolerances on power-driven staples shall comply with the manufacturer's specification and shall be suitable for use in the make and model tool specified (see [Tables 59 and 60](#)).

8.4.4 Crown width tolerances are  $\pm 1/32$  in. unless otherwise specified.

8.5 *Nominal Dimensions for Cut Nails, Type II*—Unless otherwise specified, cut nails shall be sheared from medium carbon sheet steel and shall have a wedge-shaped shank with a sheared square point end narrower than the upset head end. The designation *T* in [Tables 46-51](#) refers to sheet thickness in finished product. Other designations shall be the same as those for nails in [8.1](#).

8.6 When gage is used for a nominal diameter dimension in the application of this specification, it shall be in accordance with the decimal equivalents as shown in Specification [A 510M](#), unless otherwise specified.

## 9. Workmanship

9.1 Fasteners covered by this specification shall be true to shape, well-finished, free from imperfections, clean, and free of corrosion. Mechanically driven collated items shall be uniform and aligned properly in their assembled form for use in power tools.

## 10. Protective Coatings and Finishes

10.1 *Zinc Coating:*

10.1.1 Driven fasteners required to be zinc coated shall be cut and formed from hot-dip, hard-wiped, galvanized steel wire, electrogalvanized steel wire, or zinc flake/chromate dispersion-coated steel wire; or they shall be cut from uncoated (bright) steel wire and shall be hot-dip galvanized, electrodeposited zinc coated, mechanically deposited zinc coated, or zinc flake/chromate dispersion coated after forming. Power-driven staples are not normally zinc coated after forming.

10.1.2 Hot-dip galvanized or electrogalvanized steel wire for the manufacture of fasteners shall have a coating weight in accordance with Specification [A 641/A 641M](#), Supplementary Requirements, Class 1.

10.1.3 Hot-dip galvanized steel fasteners coated after forming shall have a coating weight in accordance with Specification [A 153/A 153M](#), Class D, when a heavier coating for exterior use is specified. If not otherwise specified, the coating weight shall be in accordance with Specification [A 641/A 641M](#), Supplementary Requirements, Class 1.

10.1.4 Mechanically deposited zinc coatings applied to fasteners after forming shall have a thickness in accordance with Specification **B 695**, Class 40, unless otherwise specified.

10.2 *Other Coatings and Finishes (When Specified):*

10.2.1 Cement coating shall be applied by tumbling, mechanical dispensing device, or immersion in resin or other similar material and shall not be tacky or gummy. Cement coatings on power-driven fasteners shall be uniform and applied before, during, or after the fasteners are cohered into strips, clips, or coils.

NOTE 4—Cement coatings increase the holding strength in withdrawal of a driven fastener, depending on the fastener size, amount of cement coating applied, and method of driving.

10.2.2 Chemical etching shall remove the polish of fabrication and roughen the surface microscopically.

10.2.3 Blued nails shall be heated to form a thin, colored oxide on the surface.

10.2.4 Miscellaneous finishes, such as tin plating, liquor, brass plating, copper plating, phosphate coating, or oil coating shall be applied.

10.3 *Altered Shapes and Deformations:*

10.3.1 Mechanically formed or deformed nail shanks shall have barbs, flutes, threads, or angular serrations formed onto the wire from which the nail is manufactured. Mechanically deformed shanks shall have vertical or helical flutes or screw-type or annular (ring)-type deformations rolled onto the shank. Symmetrical helical shank deformations shall be obtained by twisting square wire. The deformations shall pass entirely around the shank body, resulting in expanded ridges and depressions.

10.3.2 Mechanically formed or deformed nail heads shall be round or T-headed; or they shall be altered round for suitable use in a given make and model of a power-driving fastening system.

10.3.3 Staples manufactured for intended use in power tools shall comply with the tool manufacturer's specification or Type IV, Style 3 (**Table 59** or **Table 60**).

## 11. Certification

11.1 When specified in the purchase order, a producer's or supplier's certification shall be furnished to the purchaser, indicating that the fasteners are in compliance with this specification and the purchase order.

## 12. Packaging and Package Marking

12.1 Unless otherwise specified, fasteners shall be in substantial commercial containers of the type, size, and kind commonly used for the purpose, so constructed as to preserve the contents in good condition and to ensure acceptance and safe delivery by common or other carriers to the point of delivery. In addition, the containers shall be so made that the contents can be removed partially without destroying the container's ability to serve as a receptacle for the remainder of the contents.

12.2 When specified, individual packages and shipping containers shall be marked with the part-identifying number and type, length, diameter (or gage, as applicable) of the fastener, the name of the manufacturer or distributor, and the quantity or net weight.

## 13. Keywords

13.1 diameter; driven fasteners; head; length; nails; point; spikes; staples;

**TABLE 3 Type I, Style 1—Brads<sup>A</sup>**

NOTE—Steel wire, brad head, diamond point, round smooth shank, bright finish. When specified, brads shall have a modified brad head with a blunt or chiseled point for use with mechanical drivers.

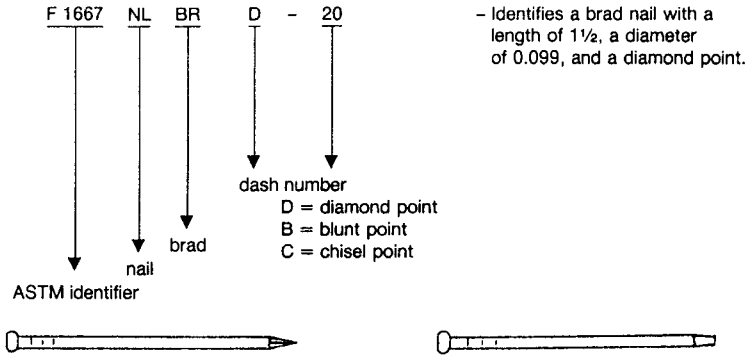

Dash No.	L	D	S	No./lb	Dash No.	L	D	S	No./lb
01	3/8	0.035	...	9520	21	1 1/4	0.062	...	670
02	1/2	0.035	...	7060	22	1 1/4	0.080	...	400
03	1/2	0.048	...	3990	23	1 1/4	0.099	5d	270
04	5/8	0.035	...	5680	24	2	0.062	...	580
05	5/8	0.048	...	3200	25	2	0.080	...	350
06	3/4	0.035	...	4800	26	2	0.113	6d	180
07	3/4	0.048	...	2620	27	2 1/4	0.080	...	320
08	3/4	0.062	...	1550	28	2 1/4	0.113	7d	160
09	7/8	0.035	...	4220	29	2 1/2	0.080	...	290
10	7/8	0.048	...	2220	30	2 1/2	0.131	8d	110
11	7/8	0.062	...	1280	31	2 3/4	0.131	9d	97
12	1	0.054	...	1500	32	3	0.148	10d	70
13	1	0.062	...	1120	33	3 1/4	0.148	12d	65
14	1	0.072	...	904	34	3 1/2	0.162	16d	50
15	1 1/4	0.054	...	1210	35	4	0.192	20d	31
16	1 1/4	0.062	...	940	36	4 1/2	0.207	30d	24
17	1 1/4	0.080	3d	560	37	5	0.225	40d	18
18	1 1/2	0.054	...	1040	38	5 1/2	0.244	50d	14
19	1 1/2	0.080	...	470	39	6	0.262	60d	11
20	1 1/2	0.099	4d	320	...	...	...	...	...

<sup>A</sup> All dimensions are given in inches.

**TABLE 4 Type I, Style 2—Barrel Nails<sup>A</sup>**

NOTE—Steel wire, flat head, diamond point, round smooth shank, bright, zinc or cement coated as specified.

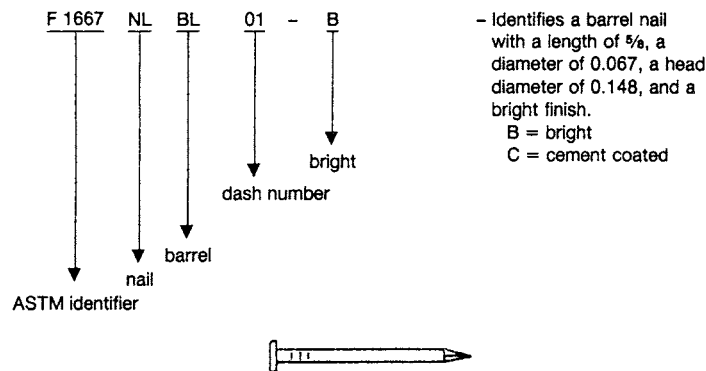

Dash No.	L	D	H	No./lb	Dash No.	L	D	H	No./lb
01	5/8	0.067	0.148	1,550	05	1 1/8	0.076	0.177	670
02	3/4	0.067	0.148	1,300	06	1 1/4	0.080	0.188	540
03	7/8	0.076	0.177	850	07	1 3/8	0.092	0.219	380
04	1	0.076	0.177	750	08	1 1/2	0.092	0.219	350

<sup>A</sup> All dimensions are given in inches.

TABLE 5 Type I, Style 3—Boat nails<sup>A</sup>

NOTE—Steel wire, oval countersunk head, chisel point, round smooth shank, bright or zinc coated as specified.

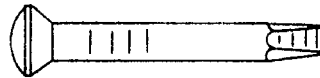
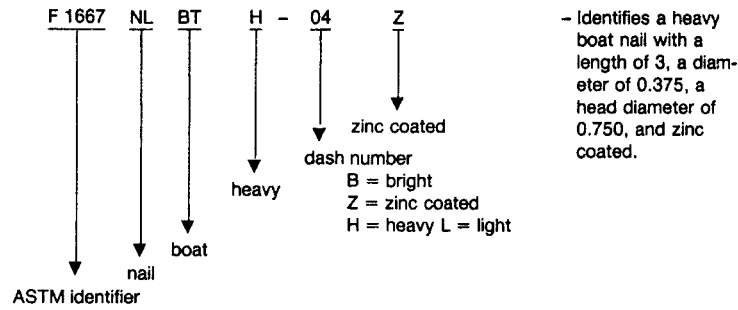

F 1667 NLBTL						F 1667 NLBTH					
Dash No.	S	L	D	H	No./lb	Dash No.	S	L	D	H	No./lb
01	4d	1½	0.188	0.406	82	01	4d	1½	0.250	0.500	47
02	6d	2	0.188	0.406	62	02	6d	2	0.250	0.500	36
03	8d	2½	0.188	0.406	50	03	8d	2½	0.250	0.500	29
04	10d	3	0.250	0.500	24	04	10d	3	0.375	0.750	11
05	12d	3¼	0.250	0.500	22	05	12d	3¼	0.375	0.750	10
06	16d	3½	0.250	0.500	20	06	16d	3½	0.375	0.750	9
07	20d	4	0.250	0.500	18	07	20d	4	0.375	0.750	8

<sup>A</sup> All dimensions are given in inches.

TABLE 6 Type I, Style 4A—Box Nails<sup>A</sup>

NOTE—Steel wire, flat head, diamond point, round, barbed or smooth shank, bright or cement coated as specified. When specified, box nails shall have an altered or T-head with a diamond, blunt, or chisel point for use with mechanical drivers.

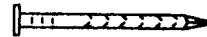
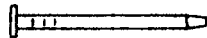
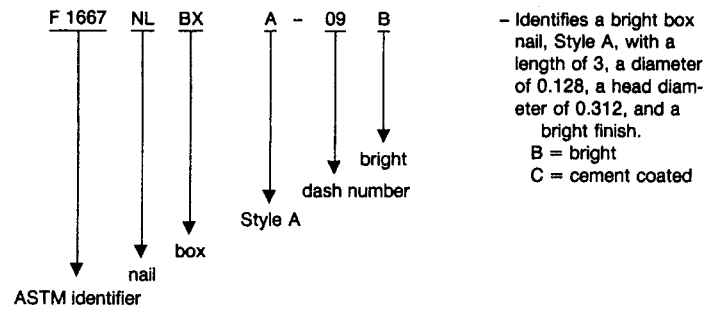

F 1667 NLBXA											
Dash No.	S	L	D	H	No./lb	Dash No.	S	L	D	H	No./lb
01	2d	1	0.067	0.188	940	08	9d	2¾	0.113	0.297	120
02	3d	1¼	0.076	0.219	590	09	10d	3	0.128	0.312	90
03	4d	1½	0.080	0.219	450	10	12d	3¼	0.128	0.312	83
04	5d	1¾	0.080	0.219	390	11	16d	3½	0.135	0.344	69
05	6d	2	0.099	0.266	220	12	20d	4	0.148	0.375	50
06	7d	2¼	0.099	0.266	200	13	30d	4½	0.148	0.375	45
07	8d	2½	0.113	0.297	140	14	40d	5	0.162	0.406	34

<sup>A</sup> All dimensions are given in inches.



**TABLE 7 Type I, Style 4B—Box Nails<sup>A</sup>**

NOTE—Steel wire, flat head, diamond point, round smooth shank, cement coated.

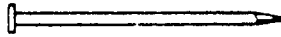
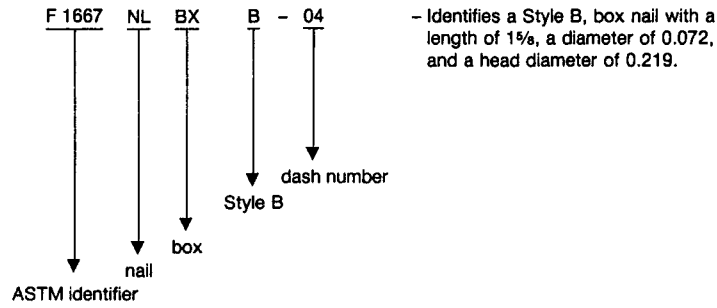

F 1667 NLBxB											
Dash No.	S	L	D	H	No./lb	Dash No.	S	L	D	H	No./lb
01	2d	1	0.058	0.172	1250	06	7d	2 1/8	0.086	0.250	280
02	3d	1 1/8	0.062	0.188	980	07	8d	2 3/8	0.099	0.266	190
03	4d	1 3/8	0.067	0.203	680	08	9d	2 5/8	0.099	0.266	170
04	5d	1 5/8	0.072	0.219	510	09	10d	2 7/8	0.113	0.297	120
05	6d	1 7/8	0.086	0.250	315	...	...	...	...	...	...

<sup>A</sup> All dimensions are given in inches.

**TABLE 8 Type I, Style 5—Broom Nails<sup>A</sup>**

NOTE—Steel wire, flat or star head, diamond point, round smooth shank, bright finish, as specified.

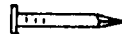
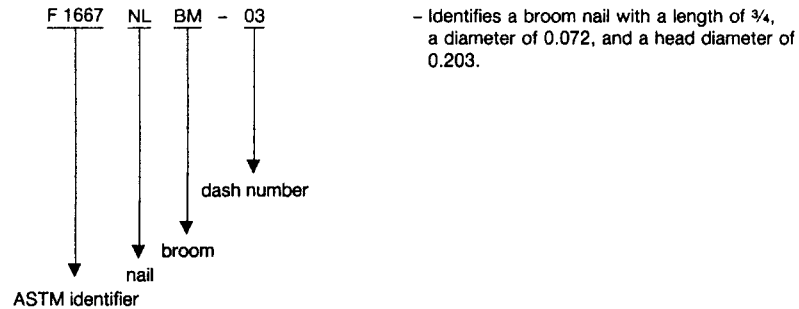

Dash No.	L	D	H	No./lb
01	5/8	0.072	0.203	1480
02	5/8	0.080	0.219	990
03	3/4	0.072	0.203	1170
04	3/4	0.080	0.219	840

<sup>A</sup> All dimensions are given in inches.

**ASTM F 1667 – 05**

**TABLE 9 Type I, Style 6—Casing Nails<sup>A</sup>**

NOTE—Steel wire, flat countersunk cupped head, diamond point, round smooth shank, bright finish.

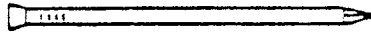
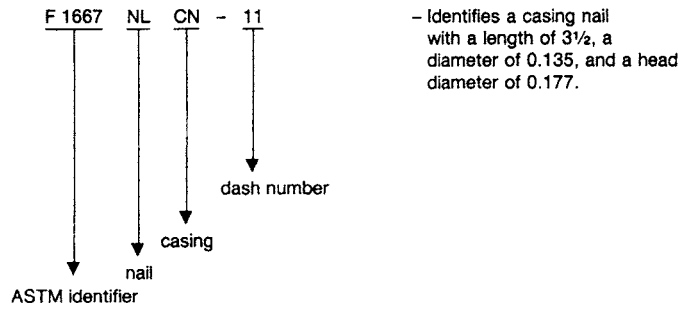

Dash No.	S	L	D	H	No./lb	Dash No.	S	L	D	H	No./lb
01	2d	1	0.067	0.099	1090	07	8d	2½	0.113	0.155	150
02	3d	1¼	0.076	0.113	650	08	9d	2¾	0.113	0.155	135
03	4d	1½	0.080	0.120	490	09	10d	3	0.128	0.170	95
04	5d	1¾	0.080	0.120	415	10	12d	3¼	0.128	0.170	90
05	6d	2	0.099	0.142	245	11	16d	3½	0.135	0.177	75
06	7d	2¼	0.099	0.142	215	...	...	...	...	...	...

<sup>A</sup> All dimensions are given in inches.

**TABLE 10 Type I, Style 7—Cooler Nails<sup>A</sup>**

NOTE—Steel wire, flat head, diamond point, round smooth shank, cement coated. When specified, coolers shall have an altered or T-head for use with mechanical drivers.

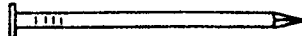
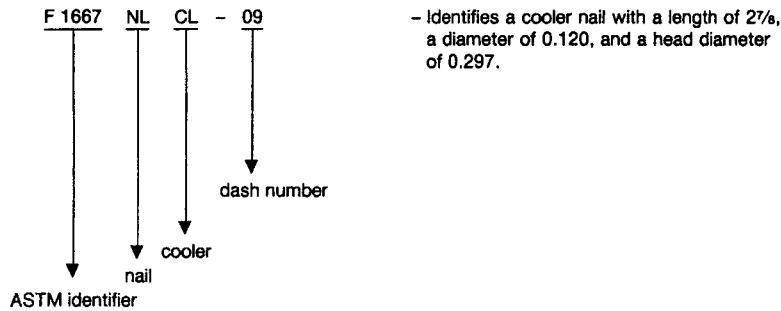

Dash No.	S	L	D	H	No./lb	Dash No.	S	L	D	H	No./lb
01	2d	1	0.062	0.172	1110	06	7d	2⅞	0.099	0.266	210
02	3d	1⅞	0.067	0.188	840	07	8d	2⅞	0.113	0.281	140
03	4d	1⅞	0.080	0.219	490	08	9d	2⅞	0.113	0.281	130
04	5d	1⅞	0.086	0.234	370	09	10d	2⅞	0.120	0.297	100
05	6d	1⅞	0.092	0.250	280	...	...	...	...	...	...

<sup>A</sup> All dimensions are given in inches.



TABLE 11 Type I, Style 8—Sinker Nails<sup>A</sup>

NOTE—Steel wire, flat countersunk head, diamond point, round smooth shank, bright or cement coated. When specified, sinkers shall have an altered or T-head for use with mechanical drivers.

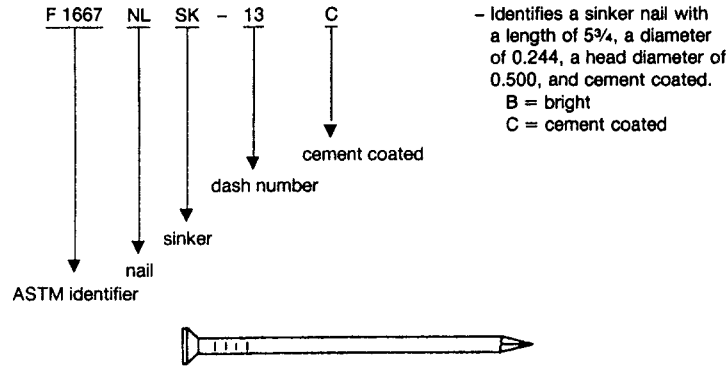

Dash No.	S	L	D	H	No./lb	Dash No.	S	L	D	H	No./lb
01	3d	1½	0.067	0.172	940	08	12d	3⅞	0.135	0.312	81
02	4d	1¾	0.080	0.203	530	09	16d	3¼	0.148	0.344	64
03	5d	1⅝	0.086	0.219	390	10	20d	3¾	0.177	0.375	40
04	6d	1⅞	0.092	0.234	290	11	30d	4¼	0.192	0.406	30
05	7d	2⅛	0.099	0.250	220	12	40d	4¾	0.207	0.438	23
06	8d	2⅜	0.113	0.266	150	13	60d	5¾	0.244	0.500	14
07	10d	2⅞	0.120	0.281	110	...	...	...	...	...	...

<sup>A</sup> All dimensions are given in inches.

TABLE 12 Type I, Style 9—Corker Nails<sup>A</sup>

NOTE—Steel wire, flat countersunk head, diamond point, round smooth shank, cement coated. When specified, corkers shall have an altered or T-head for use with mechanical drivers.

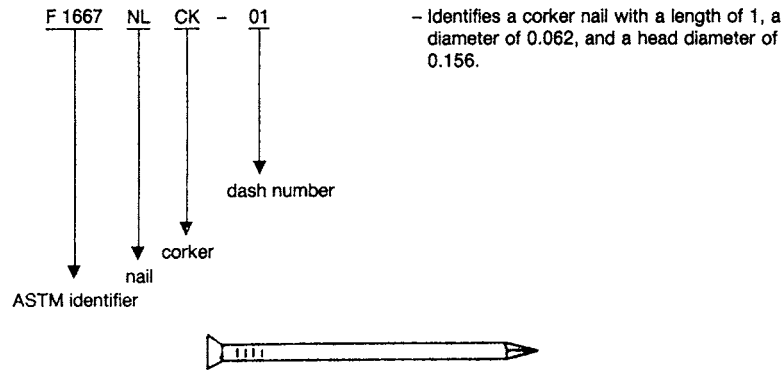

Dash No.	S	L	D	H	No./lb	Dash No.	S	L	D	H	No./lb
01	2d	1	0.062	0.156	1220	09	10d	2⅞	0.135	0.312	89
02	3d	1¼	0.072	0.188	720	10	12d	3⅞	0.135	0.312	81
03	4d	1½	0.086	0.219	420	11	16d	3⅞	0.148	0.344	62
04	5d	1⅝	0.086	0.219	320	12	20d	3⅞	0.177	0.375	38
05	6d	1⅞	0.099	0.250	250	13	30d	4¾	0.192	0.406	29
06	7d	2⅛	0.099	0.250	220	14	40d	4¾	0.207	0.438	22
07	8d	2⅜	0.120	0.281	130	15	50d	5¾	0.226	0.469	17
08	9d	2⅞	0.120	0.281	120	16	60d	5¾	0.244	0.500	13

<sup>A</sup> All dimensions are given in inches.

**TABLE 13 Type I, Style 10—Common Nails<sup>A</sup>**

NOTE—Aluminum alloy wire, flat head, diamond point, round smooth shank, or, when specified, square barbed shank.

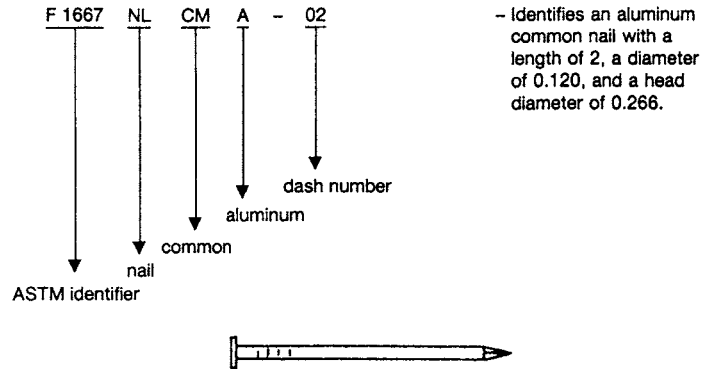

F 1667 NLCMA											
Dash No.	S	L	D	H	No./lb	Dash No.	S	L	D	H	No./lb
01	4d	1½	0.099	0.250	830	04	10d	3	0.162	0.312	170
02	6d	2	0.120	0.266	430	05	16d	3½	0.177	0.344	120
03	8d	2½	0.148	0.281	220	06	20d	4	0.199	0.406	78

<sup>A</sup> All dimensions are given in inches.

**TABLE 14 Type I, Style 10—Common Nails<sup>A</sup>**

NOTE—Copper wire, flat head, diamond point, round smooth shank.

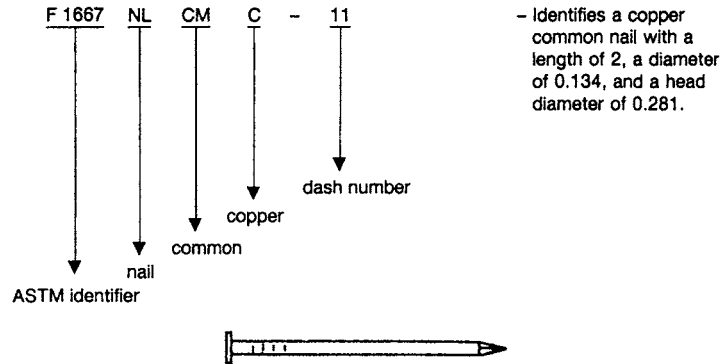

F 1667 NLCMC									
Dash No.	L	D	H	No./lb	Dash No.	L	D	H	No./lb
01	5/8	0.065	0.156	1380	10	2	0.120	0.266	130
02	3/4	0.065	0.156	1160	11	2	0.134	0.281	...
03	3/4	0.072	0.172	960	12	2½	0.134	0.281	86
04	7/8	0.072	0.172	810	13	3	0.148	0.312	56
05	1	0.072	0.172	700	14	3½	0.165	0.344	40
06	1¼	0.083	0.203	420	15	4	0.203	0.406	23
07	1½	0.109	0.250	210	16	4½	0.220	0.438	18
08	1¾	0.109	0.250	180	17	5	0.238	0.469	14
09	1¾	0.120	0.266	140	18	6	0.284	0.531	8

<sup>A</sup> All dimensions are given in inches.

**TABLE 15 Type I, Style 10—Common Nails<sup>A</sup>**

NOTE—Steel wire, flat head, diamond point, round smooth shank, bright, zinc or cement coated as specified.

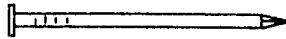
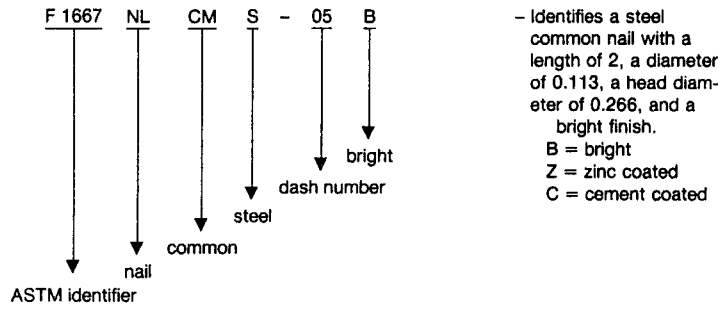

F 1667 NLCMS											
Dash No.	S	L	D	H	No./lb	Dash No.	S	L	D	H	No./lb
01	2d	1	0.072	0.172	850	09	10d	3	0.148	0.312	66
02	3d	1¼	0.080	0.203	540	10	12d	3¼	0.148	0.312	61
03	4d	1½	0.099	0.250	290	11	16d	3½	0.162	0.344	47
04	5d	1¾	0.099	0.250	250	12	20d	4	0.192	0.406	30
05	6d	2	0.113	0.266	170	13	30d	4½	0.207	0.438	23
06	7d	2¼	0.113	0.266	150	14	40d	5	0.226	0.469	17
07	8d	2½	0.131	0.281	100	15	50d	5½	0.244	0.500	14
08	9d	2¾	0.131	0.281	92	16	60d	6	0.262	0.531	11

<sup>A</sup> All dimensions are given in inches.

**TABLE 16 Type I, Style 10—Common Nails<sup>A</sup>**

NOTE—Aluminum alloy wire, or steel wire, (bright, zinc coated or cement coated), altered or T-head, diamond or chisel point, round smooth shank, as specified. For use with mechanical drivers.

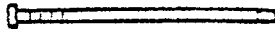
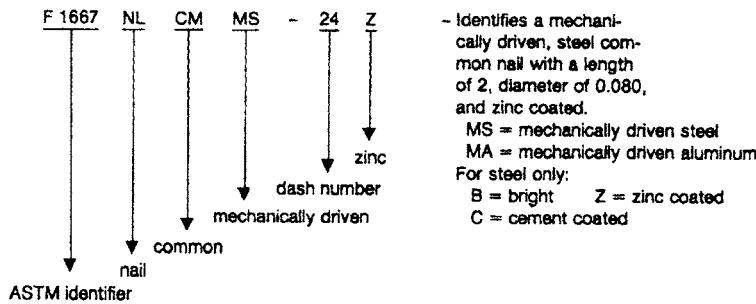

F 1667 NLCMM														
Dash No.	L	D	Dash No.	L	D	Dash No.	L	D	Dash No.	L	D	Dash No.	L	D
01	1¼	0.080	15	1¾	0.086	29	2	0.148	43	1¾	0.120	57	2⅝	0.113
02	1¼	0.086	16	1¾	0.092	30	2¼	0.092	44	1⅞	0.120	58	2⅝	0.120
03	1¼	0.092	17	1¾	0.099	31	2¼	0.099	45	1⅞	0.131	59	2⅝	0.131
04	1¼	0.099	18	1¾	0.113	32	2¼	0.113	46	1⅞	0.148	60	2⅝	0.148
05	1½	0.080	19	1⅞	0.080	33	2½	0.092	47	2	0.120	61	2½	0.120
06	1½	0.086	20	1⅞	0.086	34	2½	0.099	48	2	0.131	62	2½	0.148
07	1½	0.092	21	1⅞	0.092	35	2½	0.113	49	2⅞	0.099	63	2½	0.162
08	1½	0.099	22	1⅞	0.099	36	2½	0.131	50	2⅞	0.113	64	2⅝	0.148
09	1½	0.113	23	1⅞	0.113	37	3½	0.131	51	2⅞	0.120	65	2¾	0.120
10	1⅝	0.080	24	2	0.080	38	1½	0.120	52	2⅞	0.131	66	2¾	0.131
11	1⅝	0.086	25	2	0.086	39	1½	0.131	53	2⅞	0.148	67	2¾	0.148
12	1⅝	0.092	26	2	0.092	40	1½	0.148	54	2¼	0.120	68	2⅞	0.120
13	1⅝	0.099	27	2	0.099	41	1½	0.162	55	2¼	0.131	69	3	0.120
14	1¾	0.080	28	2	0.113	42	1⅝	0.113	56	2¼	0.148	70	3	0.128
												71	3	0.131
												72	3	0.148
												73	3¼	0.120
												74	3¼	0.131
												75	3¼	0.148
												76	3½	0.135
												77	3½	0.148
												78	3½	0.162
												79	4	0.148
												80	4	0.162
												81	4½	0.148
												82	4½	0.162
												...	...	...
												...	...	...

TABLE 17 Type I, Style 11—Concrete Nails<sup>A</sup>

NOTE—Hardened steel, flat countersunk head, diamond point, smooth or mechanically deformed shank formed from round or square stock, as specified, bright finish.

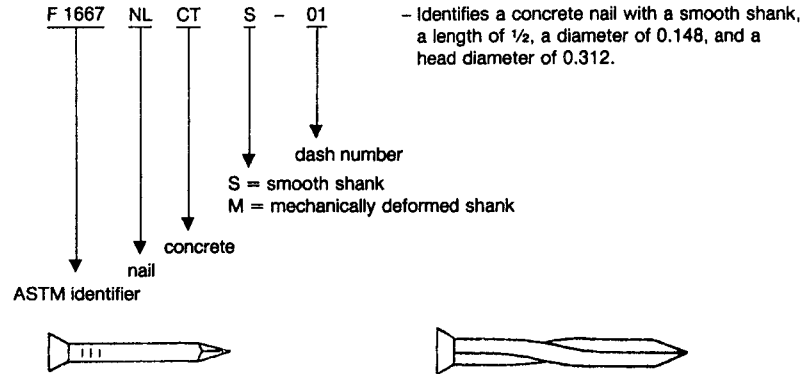

F 1667 NLCTS

Dash No.	L	D	H	No./lb
01	1/2	0.148	0.312	450
02	5/8	0.148	0.312	350
03	3/4	0.148	0.312	290
04	7/8	0.148	0.312	250
05	1	0.148	0.312	210

F 1667 NLCTM

Dash No.	L	D	H	No./lb	Dash No.	L	D	H	No./lb
01	3/4	0.181	0.284	240	05	2	0.181	0.284	93
02	1	0.181	0.284	204	06	2 1/2	0.181	0.284	68
03	1 1/2	0.181	0.284	116	07	2 3/4	0.181	0.284	60
04	1 3/4	0.181	0.284	112	08	3	0.181	0.284	52

<sup>A</sup> All dimensions are given in inches.

TABLE 18 Type I, Style 12—Double-Headed Nails<sup>A</sup>

NOTE—Steel wire, flat heads, diamond point, round smooth shank, bright finish or cement coated.

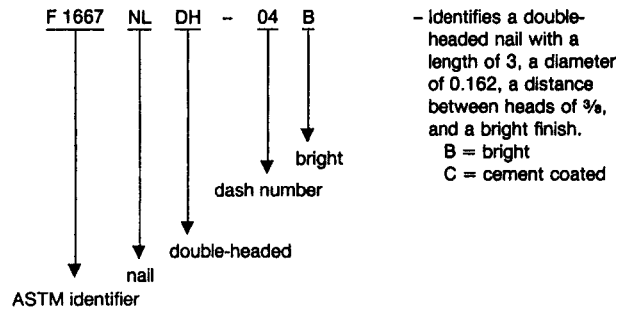

Dash No.	S	L	D	B	No./lb	Dash No.	S	L	D	B	No./lb
01	6d	1 3/4	0.113	1/4	160	04	16d	3	0.162	3/8	45
02	8d	2 1/4	0.131	1/4	90	05	20d	3 1/2	0.192	3/8	28
03	10d	2 3/4	0.148	5/16	59	06	30d	4	0.207	7/16	22

<sup>A</sup> All dimensions are given in inches.

TABLE 19 Type I, Style 13—Fine Nails<sup>A</sup>

NOTE—Steel or copper wire, flat head, diamond point, round smooth shank, bright finish.

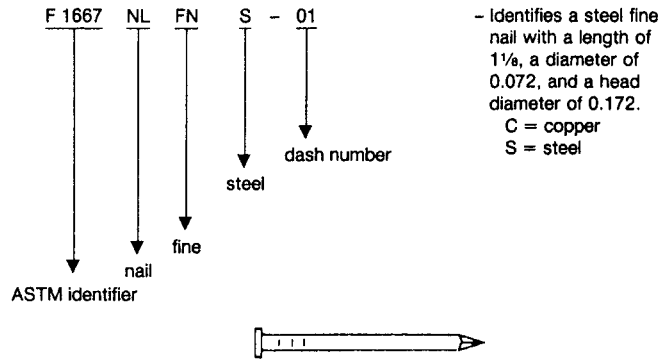

Dash No.	S	L	D	H	No./lb
01	3d	1 1/8	0.072	0.172	760

<sup>A</sup> All dimensions are given in inches.

TABLE 20 Type I, Style 14—Finish Nails<sup>A</sup>

NOTE—Steel wire, brad head, altered or clipped T-head for use with mechanical drivers, diamond or chisel point, smooth or barbed shank formed from round or square stock, as specified, bright finished.

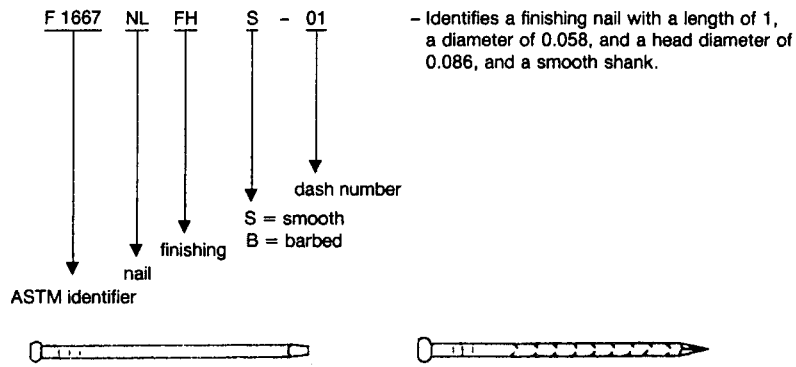

Dash No.	S	L	D	H	No./lb	Dash No.	S	L	D	H	No./lb
01	2d	1	0.058	0.086	1,470	07	8d	2 1/2	0.099	0.142	190
02	3d	1 1/4	0.067	0.099	880	08	9d	2 3/4	0.099	0.142	180
03	4d	1 1/2	0.072	0.106	630	09	10d	3	0.113	0.155	120
04	5d	1 3/4	0.072	0.106	530	10	12d	3 1/4	0.113	0.155	110
05	6d	2	0.092	0.135	290	11	16d	3 1/2	0.120	0.162	93
06	7d	2 1/4	0.092	0.135	250	12	20d	4	0.135	0.177	65

<sup>A</sup> All dimensions are given in inches.

**TABLE 21 Type I, Style 15—Flooring Nails<sup>A</sup>**

NOTE—Harded steel or steel wire, casing head or flat-cupped countersunk head, diamond or blunt point, round, smooth or mechanically deformed shank, dark (hardened), bright (steel wire) or cement coated, as specified.

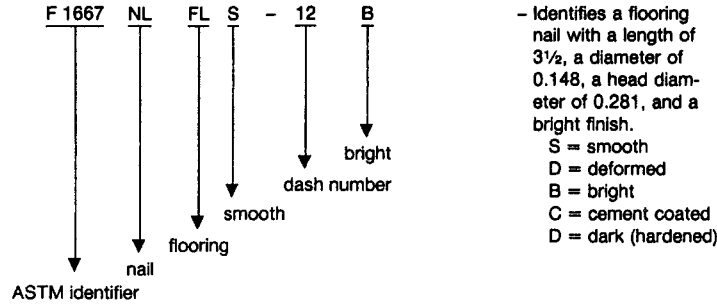

- Identifies a flooring nail with a length of 3½, a diameter of 0.148, a head diameter of 0.281, and a bright finish.  
 S = smooth  
 D = deformed  
 B = bright  
 C = cement coated  
 D = dark (hardened)

Smooth =

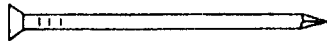

= Deformed



Dash No.	S	L	D	H	No./lb	Dash No.	S	L	D	H	No./lb
01	2d	1	0.072	0.141	840	07	7d	2¼	0.113	0.203	160
02	3d	1¼	0.072	0.141	700	08	8d	2½	0.135	0.177	100
03	4d	1½	0.080	0.156	430	09	8d	2½	0.113	0.203	110
04	4d	1½	0.092	0.156	370	10	10d	3	0.135	0.250	82
05	5d	1¾	0.092	0.156	310	11	12d	3¼	0.135	0.250	75
06	6d	2	0.113	0.203	180	12	16d	3½	0.148	0.281	58

<sup>A</sup> All dimensions are given in inches.

**TABLE 22 Type I, Style 16—Lath Nails<sup>A</sup>**

NOTE—Steel wire, flat head, diamond point, round smooth shank, blued finish.

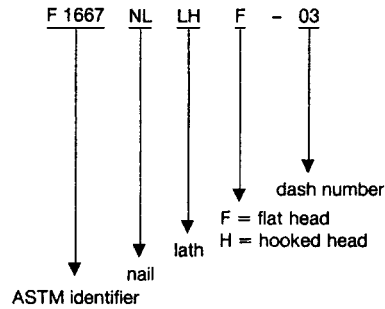

- Identifies a lath nail with a flat head, a length of 1½, a diameter of 0.072, and a head diameter of 0.172.  
 F = flat head  
 H = hooked head

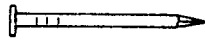

F 1667 NLLHF					
Dash No.	S	L	D	H	No./lb
01	2d	1	0.058	0.141	1,280
02	3d	1½	0.062	0.156	980
03	3d	1½	0.072	0.172	760

<sup>A</sup> All dimensions are given in inches.

TABLE 23 Type I, Style 16—Lath Nails<sup>A</sup>

NOTE—Steel wire, flat hook-head, diamond point, round smooth shank, bright, blued, or zinc coated as specified.

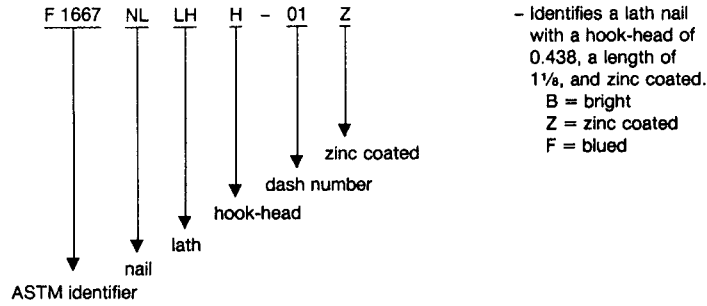

F 1667 NLLHH				
Dash No.	L	D	H	No./lb
01	1 1/8	0.106	0.438	280

<sup>A</sup> All dimensions are given in inches.

TABLE 24 Type I, Style 17—Masonry Nails<sup>A</sup>

NOTE—Hardened steel, flat or flat countersunk head, diamond point, mechanically deformed shank, bright finish.

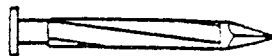
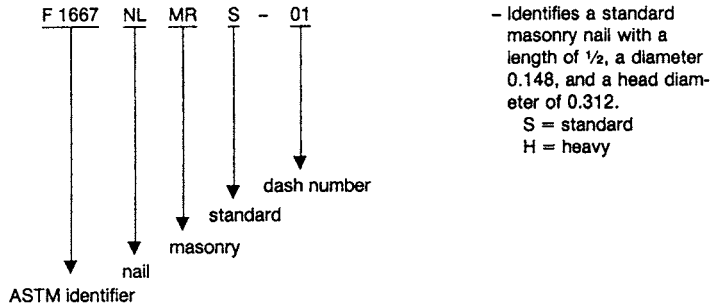

F 1667 NLMR									
Dash No.	L	D	H	No./lb	Dash No.	L	D	H	No./lb
01	1/2	0.148	0.312	340	09	2 1/2	0.148	0.312	76
02	3/4	0.148	0.312	280	10	2 3/4	0.148	0.312	70
03	1	0.148	0.312	170	11	3	0.148	0.312	67
04	1 1/4	0.148	0.312	140	12	3 1/4	0.148	0.312	60
05	1 1/2	0.148	0.312	130	13	3 1/2	0.162	0.344	48
06	1 3/4	0.148	0.312	110	14	3 3/4	0.162	0.344	45
07	2	0.148	0.312	98	15	4	0.177	0.375	35
08	2 1/4	0.148	0.312	84	...	...	...	...	...

F 1667 NLMRH									
Dash No.	L	D	H	No./lb	Dash No.	L	D	H	No./lb
01	1	0.250	0.562	63	05	2	0.250	0.562	34
02	1 1/4	0.250	0.562	47	06	2 1/2	0.250	0.562	27
03	1 1/2	0.250	0.562	43	07	3 1/2	0.250	0.562	19
04	1 3/4	0.250	0.562	39	08	3	0.250	0.562	24

<sup>A</sup> All dimensions are given in inches.



TABLE 25 Type I, Style 18—Pallet Nails<sup>A</sup>

NOTE—Hardened steel or steel wire (for mechanical drivers), flat head, altered or T-Head (for mechanical drivers), diamond point, round, mechanically deformed shank, bright finish (steel wire), or dark (hardened), as specified.

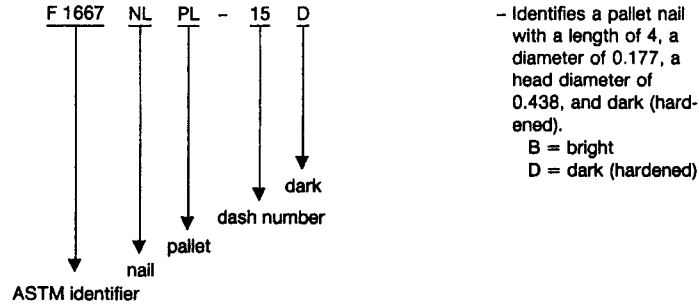

- Identifies a pallet nail with a length of 4, a diameter of 0.177, a head diameter of 0.438, and dark (hardened).  
 B = bright  
 D = dark (hardened)



Dash No.	L	D	H	No./lb	Dash No.	L	D	H	No./lb
01	1½	0.120	0.281	190	11	¾	0.148	0.312	61
02	1⅝	0.120	0.281	170	12	½	0.148	0.312	57
03	2	0.120	0.281	140	13	½	0.162	0.375	47
04	2¼	0.120	0.281	130	14	½	0.177	0.438	38
05	2½	0.120	0.281	120	15	4	0.177	0.438	35
06	2½	0.135	0.312	93	16	4	0.177	0.375	35
07	3	0.120	0.281	98	17	5	0.177	0.375	27
08	3	0.135	0.312	79	18	6	0.177	0.375	23
09	3	0.148	0.312	66	19	7	0.207	0.500	15
10	¾	0.135	0.312	73	20	8	0.207	0.500	13

<sup>A</sup> All dimensions are given in inches.

TABLE 26 Type I, Style 19—Gypsum-Wallboard, Gypsumboard, and Drywall Nails<sup>A</sup>

NOTE—Steel wire, flat head, diamond point, round smooth or deformed shank, bright or blued finish.

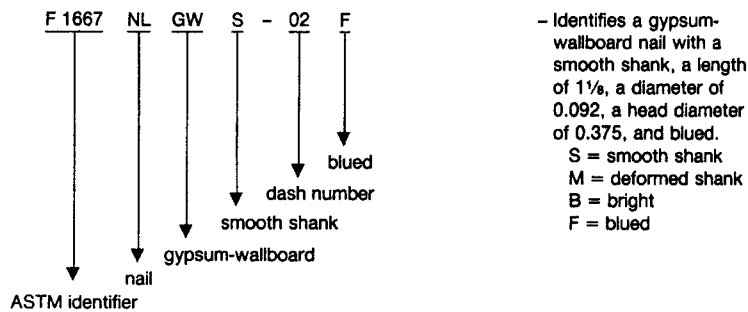

- Identifies a gypsum-wallboard nail with a smooth shank, a length of 1⅝, a diameter of 0.092, a head diameter of 0.375, and blued.  
 S = smooth shank  
 M = deformed shank  
 B = bright  
 F = blued

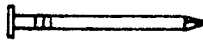

F 1667 NLGWS				
Dash No.	L	D	H	No./lb
01	1⅝	0.092	0.297	470
02	1⅝	0.092	0.375	450
03	1¼	0.092	0.297	420
04	1¼	0.106	0.375	310
05	1¾	0.092	0.375	290

<sup>A</sup> All dimensions are given in inches.

 **F 1667 – 05**

**TABLE 27 Type I, Style 19—Gypsum-Wallboard, Gypsumboard, and Drywall Nails<sup>A</sup>**

NOTE—Steel wire, flat slightly countersunk head, long diamond point, round mechanically deformed shank, bright or blued finish.

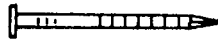

F 1667 NLGWM				
Dash No.	L	D	H	No./lb
01	1 1/8	0.099	0.250	380
02	1 1/4	0.099	0.250	340
03	1 3/8	0.099	0.250	320
04	1 1/2	0.099	0.250	290
05	1 5/8	0.099	0.250	270

<sup>A</sup> All dimensions are given in inches.

**TABLE 28 Type I, Style 20—Roofing Nails<sup>A</sup>**

NOTE—Aluminum alloy wire, flat head, diamond point, round smooth shank, or, when specified, square-barbed shank.

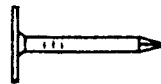
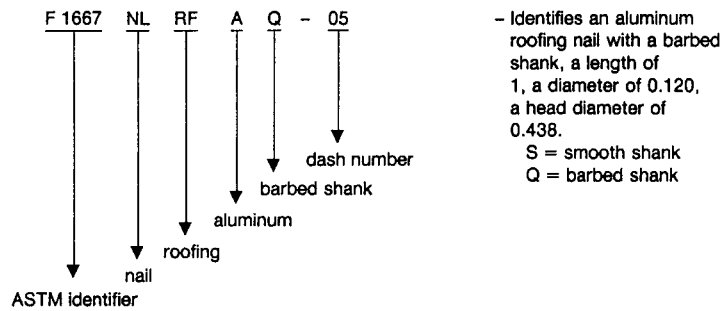

F 1667 NLRFA									
Dash No.	L	D	H	No./lb	Dash No.	L	D	H	No./lb
01	3/4	0.120	0.438	940	08	1 1/4	0.120	0.438	620
02	3/4	0.135	0.438	750	09	1 1/4	0.135	0.438	490
03	7/8	0.120	0.438	830	10	1 1/2	0.120	0.438	520
04	7/8	0.135	0.438	660	11	1 1/2	0.135	0.438	420
05	1	0.120	0.438	700	12	1 3/4	0.135	0.438	370
06	1	0.135	0.438	600	13	2	0.135	0.438	340
07	1	0.135	0.438	580	14	2 1/2	0.145	0.438	230

<sup>A</sup> All dimensions are given in inches.

**TABLE 29 Type I, Style 20—Roofing Nails<sup>A</sup>**

NOTE—Steel wire, flat head, diamond point, round, smooth or barbed shank, bright or zinc coated, as specified, for hand driving or for use with mechanical drivers.

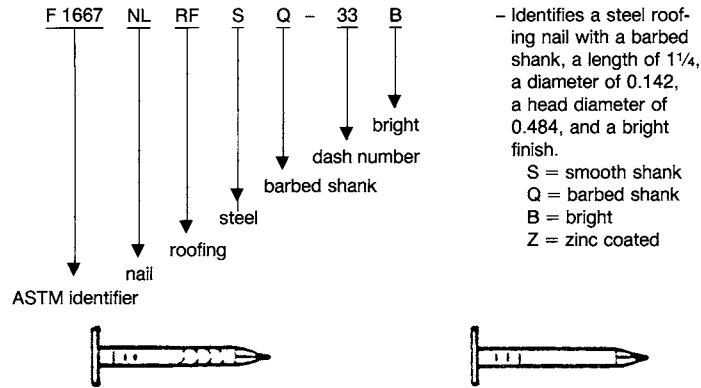

**F 1667 NLRFS**

Dash No.	L	D	H	No./lb	Dash No.	L	D	H	No./lb
01	3/4	0.106	0.375	460	29	1 1/4	0.120	0.312	240
02	3/4	0.120	0.438	340	30	1 1/4	0.120	0.438	220
03	3/4	0.135	0.469	270	31	1 1/4	0.120	0.500	...
04	3/4	0.142	0.484	240	32	1 1/4	0.135	0.469	180
05	3/4	0.148	0.500	220	33	1 1/4	0.142	0.484	160
06	3/4	0.162	0.500	200	34	1 1/4	0.148	0.500	140
07	7/8	0.106	0.375	...	35	1 1/4	0.162	0.500	120
08	7/8	0.120	0.438	300	36	1 1/2	0.106	0.375	...
09	7/8	0.120	0.500	250	37	1 1/2	0.120	0.438	180
10	7/8	0.135	0.469	240	38	1 1/2	0.120	0.500	160
11	7/8	0.142	0.484	210	39	1 1/2	0.135	0.469	150
12	7/8	0.148	0.500	190	40	1 1/2	0.142	0.484	130
13	7/8	0.162	0.500	170	41	1 1/2	0.148	0.500	120
14	1	0.106	0.281	380	42	1 1/2	0.162	0.500	110
15	1	0.106	0.375	360	43	1 3/4	0.106	0.375	220
16	1	0.120	0.438	270	44	1 3/4	0.120	0.438	160
17	1	0.120	0.500	220	45	1 3/4	0.120	0.500	140
18	1	0.135	0.469	210	46	1 3/4	0.135	0.469	130
19	1	0.142	0.484	190	47	1 3/4	0.142	0.484	120
20	1	0.148	0.500	170	48	1 3/4	0.148	0.500	110
21	1	0.162	0.500	150	49	1 3/4	0.162	0.500	92
22	1 1/8	0.106	0.375	320	50	3/4	0.120	0.375	290
23	1 1/8	0.120	0.438	240	51	7/8	0.120	0.375	259
24	1 1/8	0.135	0.469	190	52	1	0.120	0.375	232
25	1 1/8	0.142	0.484	170	53	1 1/4	0.120	0.375	209
26	1 1/8	0.148	0.500	160	54	1 1/2	0.120	0.375	179
27	1 1/8	0.162	0.500	140	55	1 3/4	0.120	0.375	157
28	1 1/4	0.106	0.375	300	...	...	...	...	...

<sup>A</sup> All dimensions are given in inches.

**TABLE 30 Type I, Style 20—Roofing Nails<sup>A</sup>**

NOTE—Copper-clad wire, flat head, diamond point, round smooth shank.

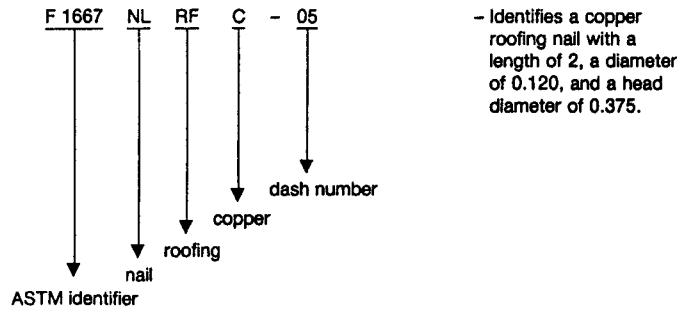

F 1667 NLRFC											
Dash No.	S	L	D	H	No./lb	Dash No.	S	L	D	H	No./lb
01	2d	1	0.120	0.375	280	04	5d	1¾	0.120	0.375	160
02	3d	1¼	0.120	0.375	220	05	6d	2	0.120	0.375	140
03	4d	1½	0.120	0.375	190	06	7d	2¼	0.120	0.375	130

<sup>A</sup> All dimensions are given in inches.

**TABLE 31 Type I, Style 20—Roofing Nails<sup>A</sup>**

NOTE—Steel wire, leak-resistant convex head, diamond point, round smooth shank, zinc coated.

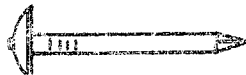
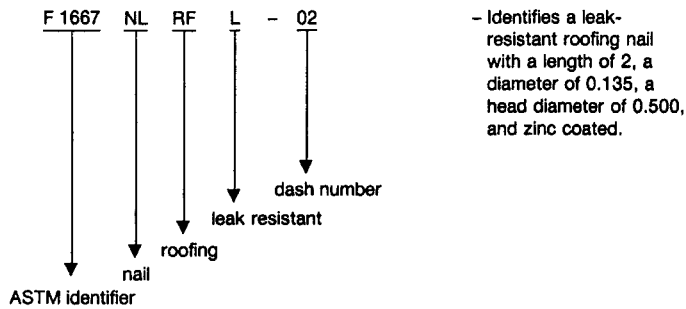

F 1667 NLRFL				
Dash No.	L	D	H	No./lb
01	1¾	0.135	0.500	110
02	2	0.135	0.500	98

<sup>A</sup> All dimensions are given in inches.

**TABLE 32 Type I, Style 20—Roofing Nails<sup>A</sup>**

NOTE—Steel wire, flat reinforced head, needle or diamond point, round smooth shank, bright or zinc coated, as specified. (For prepared felt roofing.)

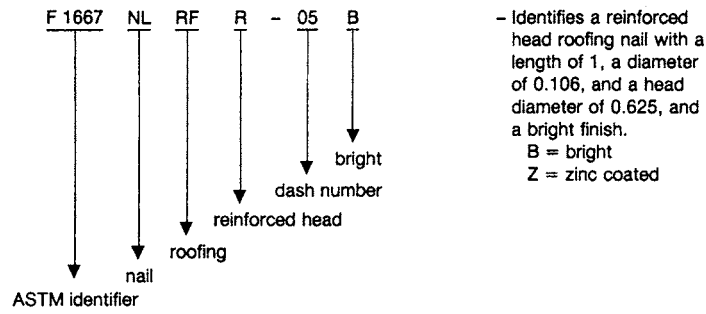

F 1667 NLRFR									
Dash No.	L	D	H	No./lb	Dash No.	L	D	H	No./lb
01	3/4	0.106	0.625	190	06	1	0.120	0.625	150
02	3/4	0.120	0.625	170	07	1 1/8	0.106	0.625	170
03	7/8	0.106	0.625	180	08	1 1/8	0.120	0.625	140
04	7/8	0.120	0.625	160	09	1 1/4	0.106	0.625	160
05	1	0.106	0.625	170	10	1 1/4	0.106	0.625	140

<sup>A</sup> All dimensions are given in inches.

**TABLE 33 Type I, Style 20—Roofing Nails<sup>A</sup>**

NOTE—Steel wire, 1-in. flat integral steel cap, diamond point, round mechanically deformed shank, bright finish for roofing felts.

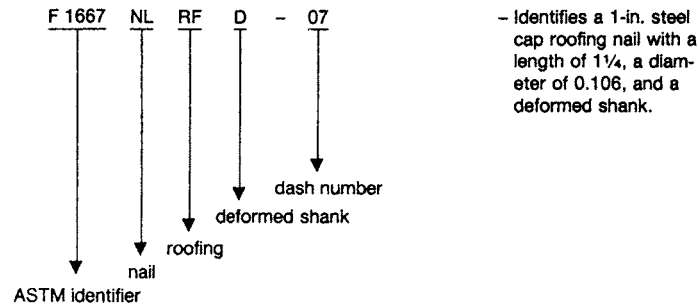

F 1667 NLRFD							
Dash No.	L	D	No./lb	Dash No.	L	D	No./lb
01	1/2	0.106	130	07	1 1/4	106	100
02	5/8	0.106	120	08	1 1/2	106-120	96-84
03	3/4	0.106	115	09	1 3/4	106-120	94-85
04	7/8	0.106	110	10	2	106-120	90-74
05	1	0.106	110	11	2 1/2	106-120	80-61
06	1 1/8	0.106	110	12	3	106	70

<sup>A</sup> All dimensions are given in inches.

**ASTM F 1667 – 05**

**TABLE 34 Type I, Style 20—Roofing Nails<sup>A</sup>**

NOTE—Aluminum alloy wire, flat head with neoprene washer (for aluminum roofing sheet), diamond point, round, smooth, or mechanically deformed shank, as specified.

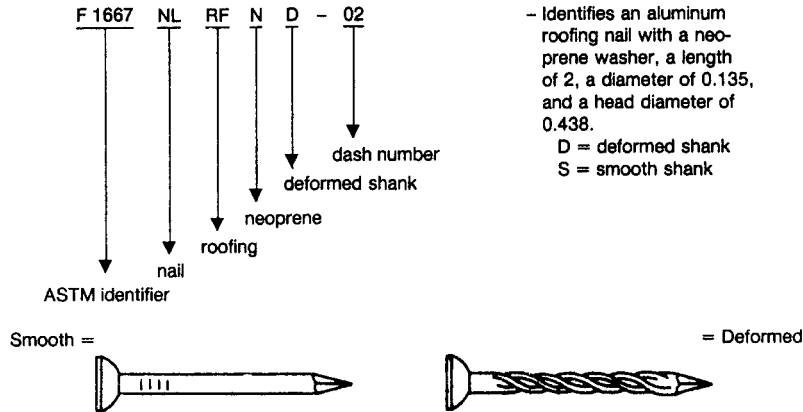

F 1667 NLRFNS					F 1667 NLRFND				
Dash No.	L	D	H	No./lb	Dash No.	L	D	H	No./lb
01	1¼	0.135	0.438	320	01	1¼	0.145	0.438	290
02	2	0.135	0.438	280	02	2	0.145	0.438	260
03	2¼	0.135	0.438	240	03	2¼	0.145	0.438	230
04	2½	0.135	0.438	210	04	2½	0.145	0.438	210

<sup>A</sup> All dimensions are given in inches.

**TABLE 35 Type I, Style 21—Shingle Nails<sup>A</sup>**

NOTE—Aluminum Alloy wire, flat head, diamond point, round, smooth or mechanically deformed shank, as specified.

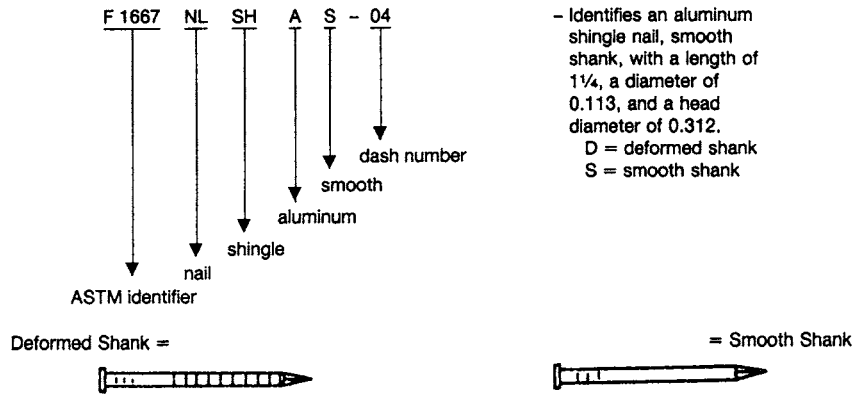

F 1667 NLSHAD					F 1667 NLSHAS				
Dash No.	L	D	H	No./lb	Dash No.	L	D	H	No./lb
01	1¼	0.101	0.191	1060	01	7/8	0.099	0.281	1310
02	1½	0.101	0.191	860	02	1¼	0.080	0.219	1480
03	1¾	0.105	0.191	720	03	1¼	0.099	0.281	1010
04	2	0.105	0.191	610	04	1¼	0.113	0.312	780
05	2¼	0.113	0.200	180	05	1½	0.113	0.312	660
06	2½	0.113	0.200	130	06	1¾	0.113	0.312	610

<sup>A</sup> All dimensions are given in inches.

TABLE 36 Type I, Style 21—Shingle Nails<sup>A</sup>

NOTE—Steel wire, flat head, diamond point, round, smooth (standard) or barbed (for special shingles) shank, bright or zinc coated, as specified.

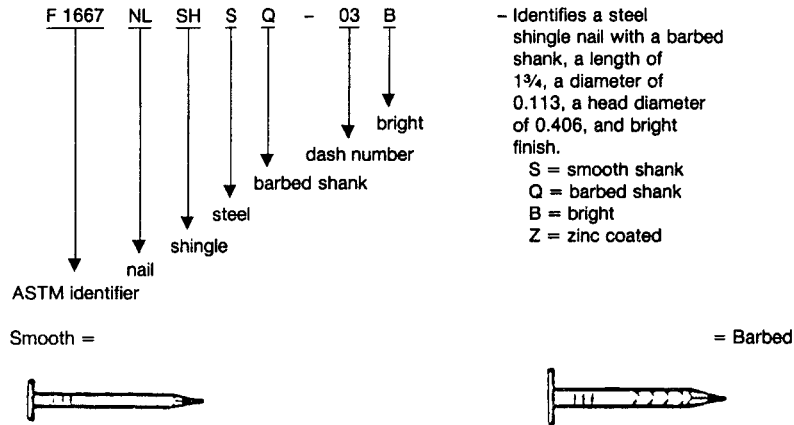

F 1667 NLSHSS						F 1667 NLSHNSB				
Dash No.	S	L	D	H	No./lb	Dash No.	L	D	H	No./lb
01	3d	1¼	0.092	0.250	410	01	1¼	0.113	0.406	250
02	3.5d	1⅜	0.099	0.281	310	02	1½	0.113	0.406	210
03	4d	1½	0.106	0.281	260	03	1¾	0.113	0.406	180
...	...	...	...	...	...	04	2	0.113	0.406	162

<sup>A</sup> All dimensions are given in inches.

TABLE 37 Type I, Style 22—Siding Nails<sup>A</sup>

NOTE—Aluminum alloy wire, flat head (insulated), casing or countersunk head (wood), as specified, diamond point, round smooth shank or, when specified, square-barbed shank.

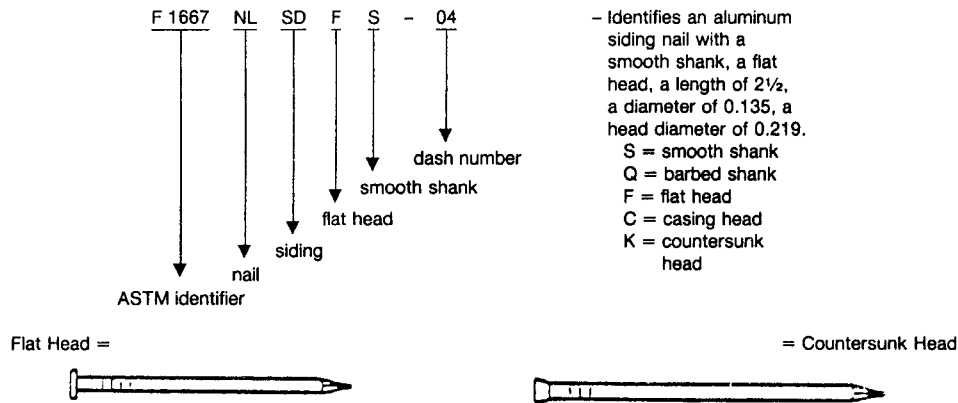

F 1667 NLSDF					F 1667 NLSDC						F 1667 NLSDK					
Dash No.	L	D	H	No./lb	Dash No.	S	L	D	H	No./lb	Dash No.	S	L	D	H	No./lb
01	1½	0.113	0.219	700	01	6d	1⅞	0.106	0.266	600	01	6d	1⅞	0.106	0.266	600
02	1½	0.113	0.312	660	02	7d	2⅞	0.113	0.266	470	02	7d	2⅞	0.113	0.266	470
03	2	0.113	0.219	490	03	8d	2⅞	0.128	0.297	320	03	8d	2⅞	0.128	0.297	320
04	2½	0.135	0.219	290	04	9d	2⅞	0.148	0.312	200	04	9d	2⅞	0.148	0.312	200

<sup>A</sup> All dimensions are given in inches.



**TABLE 38 Type I, Style 23—Slating Nails<sup>A</sup>**

NOTE—Aluminum alloy, copper or steel wire as specified. Aluminum and copper nails shall have a flat head (0.312 to 0.375-in. diameter), diamond point, and round smooth shank or, when specified, square-barbed shank. Steel nails shall have a flat, slightly countersunk head, diamond point, round smooth shank, zinc coated.

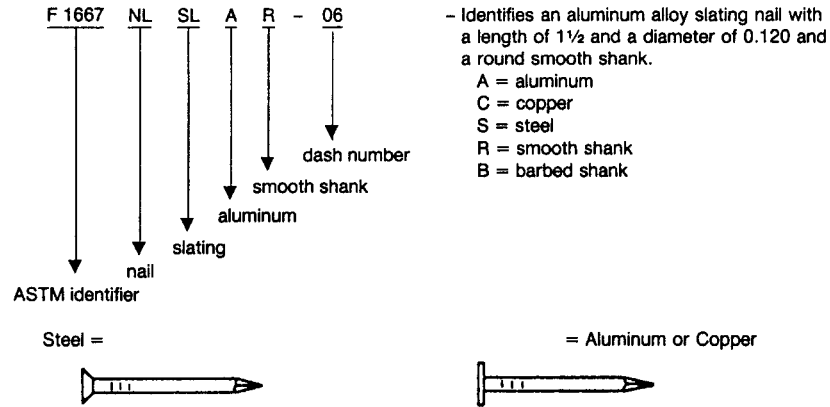

F 1667 NLSLA					
Dash No.		L	D		No./lb
01		7/8	0.106		1170
02		1	0.106		1150
03		1¼	0.106		670
04		1¼	0.120		620
05		1¼	0.135		520
06		1½	0.120		530
07		1½	0.135		430
F 1667 NLSLC					
01		1	0.109		290
02		1¼	0.109		240
03		1¼	0.120		210
04		1¼	0.135		160
05		1½	0.109		200
06		1½	0.120		160
07		1½	0.135		130
08		1¾	0.135		120
09		2	0.135		110
F 1667 NLSLS					
Dash No.	S	L	D	H	No./lb
01	2d	1	0.106	0.312	420
02	3d	1¼	0.128	0.375	220
03	4d	1½	0.128	0.375	190
04	5d	1¾	0.135	0.406	140
05	6d	2	0.148	0.438	100

<sup>A</sup> All dimensions are given in inches.

TABLE 39 Type I, Style 24—Rubber Heel Nails<sup>A</sup>

NOTE—Steel wire, flat or countersunk head, as specified, needle point, round smooth shank, bright finish.

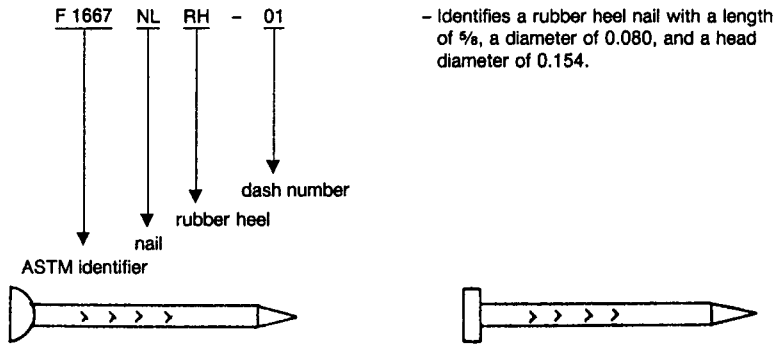

Dash No.	L	D	H	Dash No.	L	D	H
01	5/8	0.080	0.154	04	1	0.080	0.154
02	3/4	0.080	0.154	05	1 1/8	0.080	0.154
03	7/8	0.080	0.154	06	1 1/4	0.080	0.154

<sup>A</sup> All dimensions are given in inches.

TABLE 40 Type I, Style 25—Underlayment Nails<sup>A</sup>

NOTE—Steel wire, flat or flat, slightly countersunk head, diamond point, round, mechanically deformed shank, bright finish.

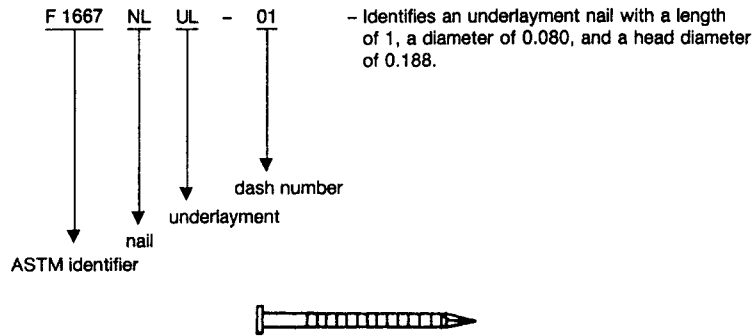

Dash No.	L	D	H	No./lb	Dash No.	L	D	H	S	No./lb
01	1	0.080	0.188	...	07	1 1/2	0.099	0.250	...	330
02	1 1/4	0.080	0.188	600	08	1 3/8	0.099	0.250	...	300
03	1 1/4	0.099	0.250	400	09	1 3/4	0.099	0.250	...	280
04	1 3/8	0.080	0.188	540	10	1 7/8	0.106	0.266	6d	170
05	1 3/8	0.099	0.250	360	11	2 1/8	0.109	0.266	7d	170
06	1 1/2	0.080	0.188	500	12	2 3/8	0.113	0.297	8d	140

<sup>A</sup> All dimensions are given in inches.

**TABLE 41 Type I, Style 26—Barbed Nails<sup>A</sup>**

NOTE—Steel wire, flat head, diamond point, square barbed shank, bright finish.

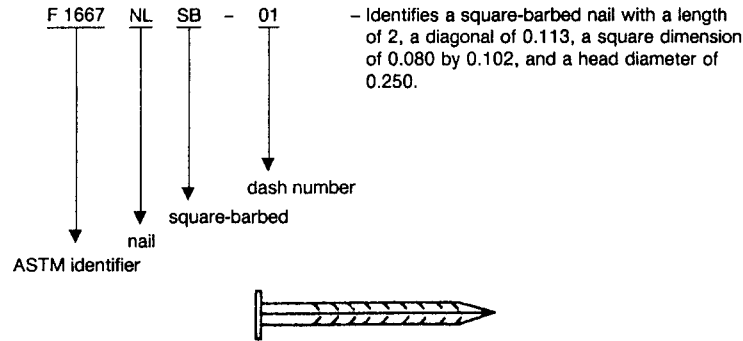

Dash No.	S	Style	L	Diagonal	Square Dimension	H	No./lb
01	6d	common	2	0.113	0.080 × 0.102	0.250	200
02	8d	common	2½	0.131	0.092 × 0.120	0.266	120
03	10d	common	3	0.148	0.105 × 0.135	0.281	84
04	16d	common	3½	0.162	0.113 × 0.149	0.312	59
05	20d	common	4	0.192	0.135 × 0.170	0.375	39
06	6d	box	2	0.099	0.072 × 0.089	0.250	260
07	8d	box	2½	0.113	0.080 × 0.102	0.266	150
08	6d	finish	2	0.092	0.062 × 0.083	0.124	320
09	8d	finish	2½	0.099	0.072 × 0.089	0.131	230
10	...	truss	1½	0.131	0.092 × 0.120	0.281	190

<sup>A</sup> All dimensions are given in inches.

**TABLE 42 Type I, Style 27—Masonry Drive Nails<sup>A</sup>**

NOTE—Hardened steel, flat head, cone pilot point, round, high pitch, multiple-start threaded shank, bright finish. When specified, masonry drive nails shall be proof lead tested.

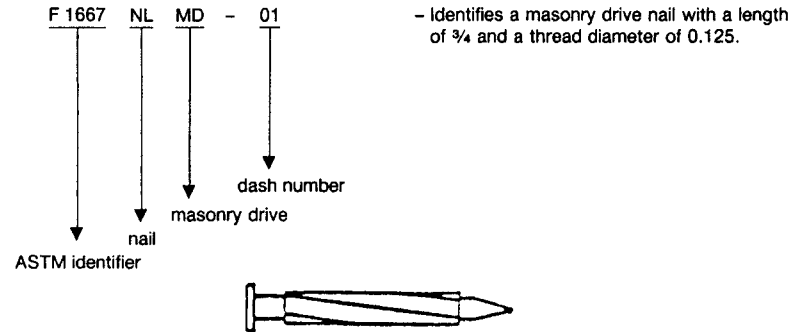

Dash No.	S	L	Thread Diameter	Dash No.	S	L	Thread Diameter
01	3/32	¾	0.125	4	3/16	1¼	0.215
02	1/8	¾	0.156	5	¼	1½	0.258
03	5/32	1	0.188	6	5/16	2	0.330

<sup>A</sup> All dimensions are given in inches.

TABLE 43 Type I, Style 28—Escutcheon Nails<sup>A</sup>

NOTE—Steel or brass wire, as specified, oval head, diamond point, round smooth shank.

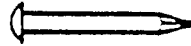
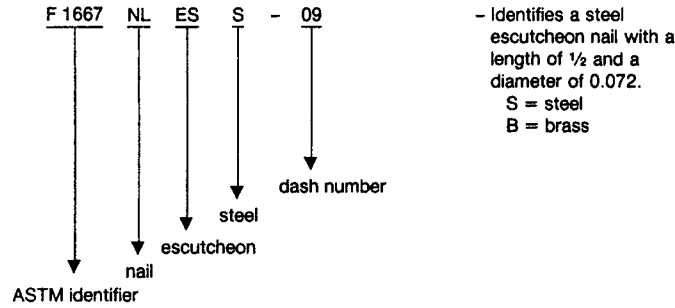

Dash No.	L	D	Dash No.	L	D	Dash No.	L	D
01	1/4	0.035	14	3/4	0.072	27	2	0.080
02	1/4	0.048	15	3/4	0.080	28	2	0.092
03	1/4	0.062	16	3/4	0.092	...	...	...
04	1/4	0.072	17	1	0.048	...	...	...
05	1/4	0.080	18	1	0.062	...	...	...
06	1/2	0.035	19	1	0.072	...	...	...
07	1/2	0.048	20	1	0.080	...	...	...
08	1/2	0.062	21	1	0.092	...	...	...
09	1/2	0.072	22	1 1/4	0.062	...	...	...
10	1/2	0.080	23	1 1/4	0.080	...	...	...
11	1/2	0.092	24	1 1/4	0.092	...	...	...
12	3/4	0.048	25	1 1/2	0.080	...	...	...
13	3/4	0.062	26	1 1/2	0.092	...	...	...

<sup>A</sup> All dimensions are given in inches.

TABLE 44 Type I, Style 29—Glulam Rivet<sup>A</sup>

NOTE—Hardened steel, flat countersunk head, diamond point, smooth shank, zinc coated, as specified.

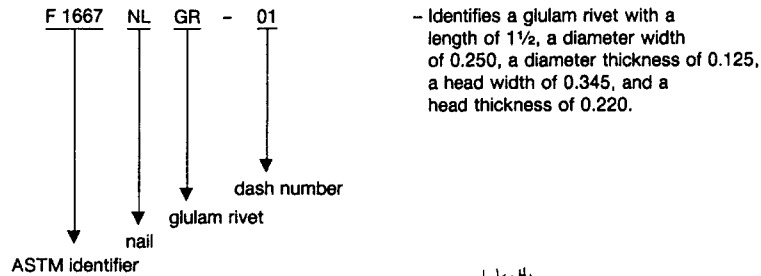

Dash No.	L	D <sub>width</sub> <sup>B</sup>	D <sub>thickness</sub> <sup>B</sup>	H <sub>width</sub> <sup>B</sup>	H <sub>thickness</sub> <sup>B</sup>	No./lb
01	1 1/2	0.250	0.125	0.345	0.220	59
02	2 1/2	0.250	0.125	0.345	0.220	34
03	3 1/2	0.250	0.125	0.345	0.220	24

<sup>A</sup> All dimensions are given in inches.

<sup>B</sup> Tolerances: D<sub>w</sub> - ±0.010, D<sub>t</sub> - ±0.005, H<sub>w</sub> - ±0.010, and H<sub>t</sub> - ±0.010.

**TABLE 45 Type I, Style 30—Post-Frame Shank Nails<sup>A</sup>**

NOTE—Steel, flat head, diamond point, round, mechanically deformed shank, bright or zinc-coated as specified. Nails shall comply with the supplementary requirements of S1 and Table S1.2.

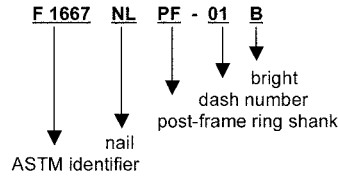

- Identifies a hardened steel deformed shank post-frame nail with a diameter of .135, bright

B = bright  
Z = zinc coated

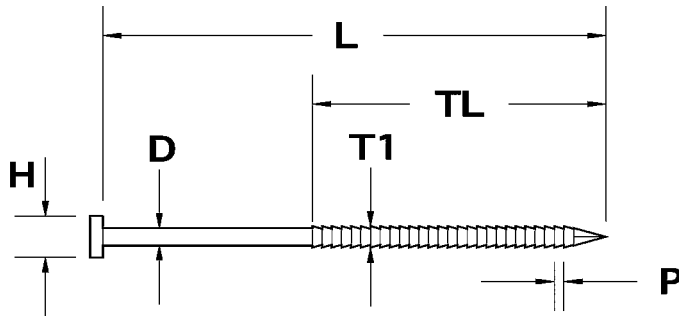

Dash No.	L	D	H	T1-D max	T1-D min	TL min	P <sub>max</sub>	P <sub>min</sub>	Root Diameter <sup>B</sup>
01	3	0.135	5/16	.010	.005	2.25	.077	.050	0.128
02	3	0.148	5/16	.010	.005	2.25	.077	.050	0.140
03	3	0.177	3/8	.010	.005	2.25	.077	.050	0.169
04	3.5	0.135	5/16	.010	.005	2.25	.077	.050	0.128
05	3.5	0.148	5/16	.010	.005	2.25	.077	.050	0.140
06	3.5	0.177	3/8	.010	.005	2.25	.077	.050	0.169
07	3.5	0.200	15/32	.010	.005	2.25	.077	.050	0.193
08	4	0.148	5/16	.010	.005	2.25	.077	.050	0.140
09	4	0.177	3/8	.010	.005	2.25	.077	.050	0.169
10	4	0.200	15/32	.010	.005	2.25	.077	.050	0.193
11	4	0.207	15/32	.010	.005	2.25	.077	.050	0.199
12	4.5	0.148	5/16	.010	.005	3	.077	.050	0.140
13	4.5	0.177	3/8	.010	.005	3	.077	.050	0.169
14	4.5	0.200	15/32	.010	.005	3	.077	.050	0.193
15	4.5	0.207	15/32	.010	.005	3	.077	.050	0.199
16	5	0.177	3/8	.010	.005	3	.077	.050	0.169
17	5	0.200	15/32	.010	.005	3	.077	.050	0.193
18	5	0.207	15/32	.010	.005	3	.077	.050	0.199
19	6	0.177	3/8	.010	.005	3	.077	.050	0.169
20	6	0.200	15/32	.010	.005	3	.077	.050	0.193
21	6	0.207	15/32	.010	.005	3	.077	.050	0.199
22	8	0.177	3/8	.010	.005	3	.077	.050	0.169
23	8	0.200	15/32	.010	.005	3	.077	.050	0.193
24	8	0.207	15/32	.010	.005	3	.077	.050	0.199

- L = length, in.,
- H = head diameter, in.,
- TL = length of threaded shank, in.,
- max = maximum acceptable value (not subject to tolerances),
- min = minimum acceptable value (not subject to tolerances),
- D = shank diameter, in.,
- T1 = crest diameter, in., and
- P = pitch, or spacing of threads, in.

<sup>A</sup>All dimensions are given in inches.

<sup>B</sup>Root diameter is a calculated value and is not specified as a dimension to be measured.

**TABLE 46 Type II, Style 1—Common Cut Nails<sup>A</sup>**

NOTE—Steel or copper, flat head, bright finish.

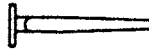
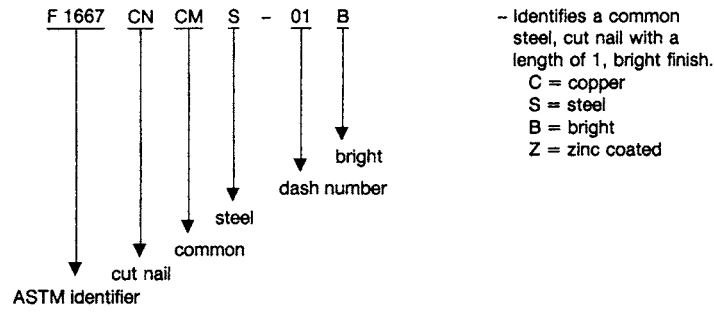

Dash No.	S	L	Dash No.	S	L	Dash No.	S	L
01	2d	1	07	7d	2¼	13	20d	4
02	3d	1¼	08	8d	2½	14	30d	4½
03	3½d	1¾	09	9d	2¾	15	40d	5
04	4d	1½	10	10d	3	16	50d	5½
05	5d	1¾	11	12d	3¼	17	60d	6
06	6d	2	12	16d	3½	...	...	...

<sup>A</sup> All dimensions are given in inches.

**TABLE 47 Type II, Style 2—Basket Cut Nails<sup>A</sup>**

NOTE—Steel, flat head, bright finish.

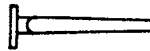
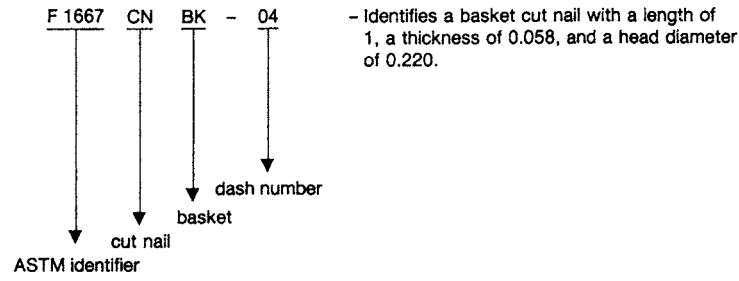

Dash No.	L	T	H	No./lb
01	5/8	0.049	0.180	2080
02	¾	0.049	0.180	1500
03	7/8	0.058	0.203	1060
04	1	0.058	0.220	930

<sup>A</sup> All dimensions are given in inches.

**TABLE 48 Type II, Style 3—Clout Cut Nails<sup>A</sup>**

NOTE—Steel, flat head, bright finish, blued or zinc coated, as specified (see 5).

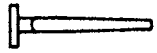
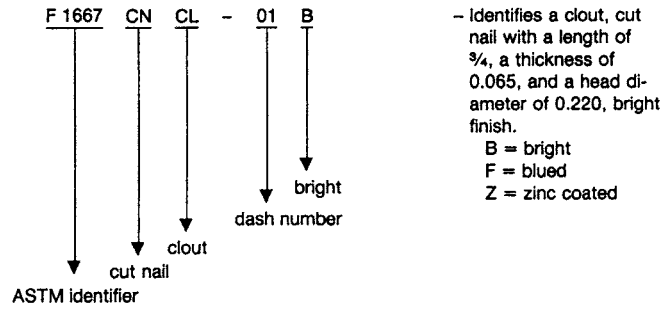

Dash No.	L	T	H	No./lb
01	3/4	0.065	0.220	960
02	7/8	0.0685	0.238	770
03	1	0.072	0.259	580
04	1 1/4	0.0775	0.284	380

<sup>A</sup> All dimensions are given in inches.

**TABLE 49 Type II, Style 4—Trunk Cut Nails<sup>A</sup>**

NOTE—Steel, oval head, bright finish, blued, brass or copper plated, as specified.

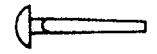
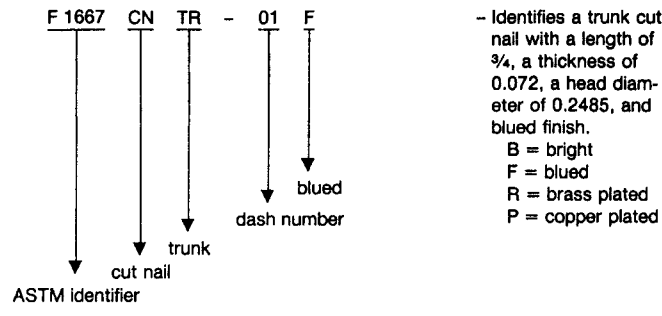

Dash No.	L	T	H	No./lb
01	3/4	0.072	0.2485	670
02	7/8	0.072	0.2485	610
03	1	0.083	0.2715	450
04	1 1/4	0.083	0.2715	350

<sup>A</sup> All dimensions are given in inches.



**TABLE 50 Type II, Style 5—Cobblers Cut Nails<sup>A</sup>**

NOTE—Steel casing head, clinch point, bright finish or brass plated, as specified.

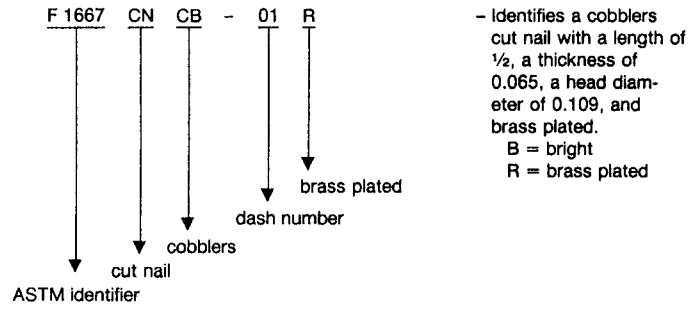

Dash No.	L	T	H	No./lb
01	1/2	0.065	0.109	1950
02	5/8	0.065	0.109	1500
03	3/4	0.065	0.109	1340

<sup>A</sup> All dimensions are given in inches.

**TABLE 51 Type II, Style 6—Extra-Iron Clinching Cut Nails<sup>A</sup>**

NOTE—Steel, casing head, clinch point, bright finish or blued, as specified.

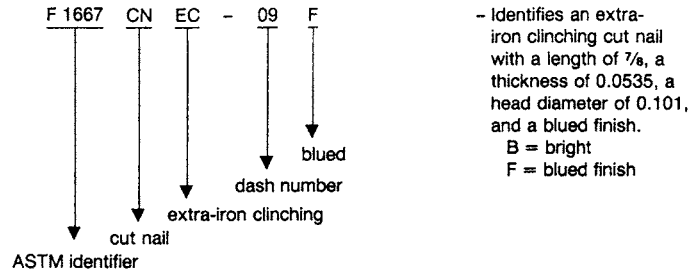

Dash No.	L	T	H	No./lb	Dash No.	L	T	H	No./lb
01	3/8	0.049	0.093	4.130	06	11/16	0.049	0.093	2000
02	7/16	0.049	0.093	3.400	07	3/4	0.0535	0.101	1640
03	1/2	0.049	0.093	3.040	08	13/16	0.0535	0.101	1600
04	9/16	0.049	0.093	2.864	09	7/8	0.0535	0.101	1520
05	5/8	0.049	0.093	2.260	...	...	...	...	...

<sup>A</sup> All dimensions are given in inches.

**TABLE 52 Type II, Style 7—Hob Cut Nails<sup>A</sup>**

NOTE—Steel, square grooved head, clinch point, bright finish, or blued, as specified.

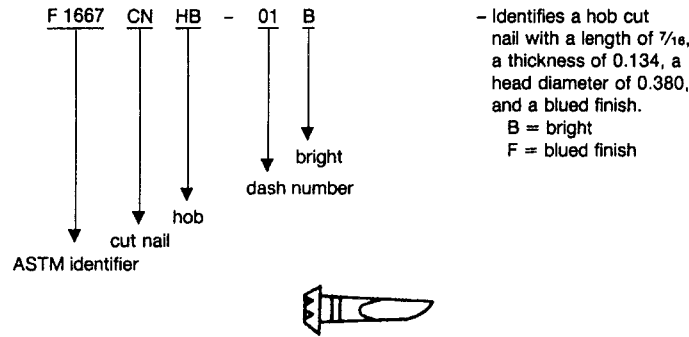

Dash No.	L	T	H	No./lb
01	$\frac{7}{16}$	0.134	0.380	270
02	$\frac{1}{2}$	0.134	0.380	260

<sup>A</sup> All dimensions are given in inches.

**TABLE 53 Type III, Style 1—Common Spikes<sup>A</sup>**

NOTE—These spikes shall be sheared from medium carbon sheet steel and shall have a wedged-shaped shank with a square point end narrower than the upset head end. They shall have a flat head, bright finish, or zinc coated, as specified.

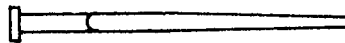
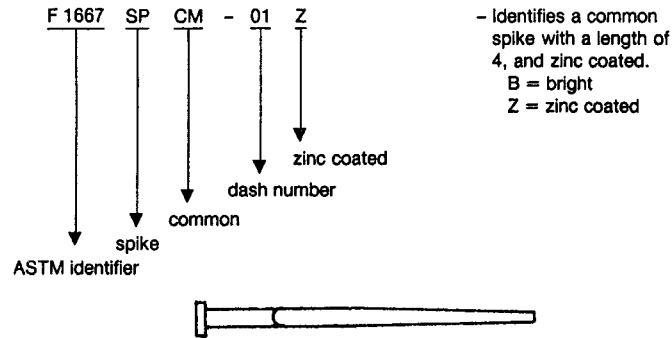

Dash No.	S	L	Dash No.	S	L
01	20d	4	05	60d	6
02	30d	4½	06	80d	7
03	40d	5	07	100d	8
04	50d	5½	...	...	...

<sup>A</sup> All dimensions are given in inches.

**ASTM F 1667 – 05**

**TABLE 54 Type III, Style 2—Gutter Spikes<sup>A</sup>**

NOTE—Steel wire, oval head, chisel point, flat head, diamond point, bright finish or zinc coated, as specified.

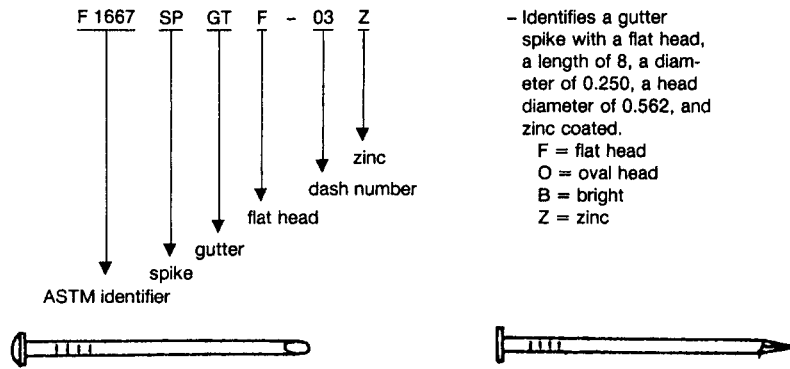

F 1667 SPGTF			
Dash No.	L	D	H
01	6½	0.250	0.562
02	7	0.250	0.562
03	8	0.250	0.562
04	8½	0.250	0.562
05	9	0.250	0.562
06	10	0.250	0.562
07	10½	0.250	0.562

  

F 1667 SPGTO			
Dash No.	L	D	H
01	6½	0.250	0.531
02	7	0.250	0.531
03	8	0.250	0.531
04	8½	0.250	0.531
05	9	0.250	0.531
06	10	0.250	0.531
07	10½	0.250	0.531

<sup>A</sup> All dimensions are given in inches.

**TABLE 55 Type III, Style 3—Round Spikes<sup>A</sup>**

NOTE—Steel wire, oval countersunk head, chisel point, flat head, diamond point, bright finish or zinc coated, as specified.

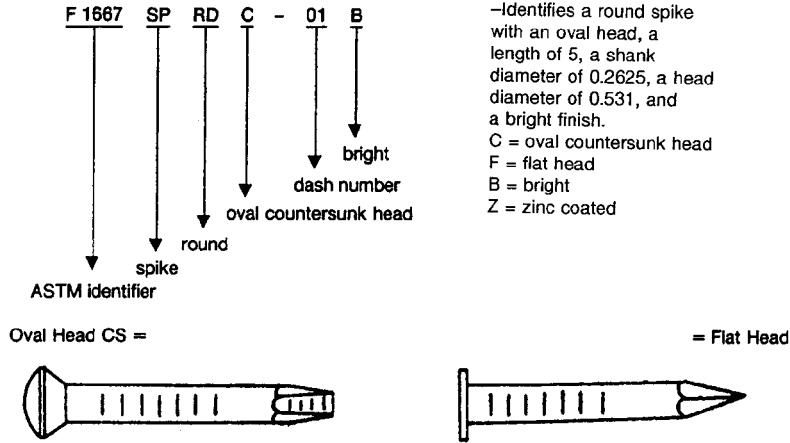

—Identifies a round spike with an oval head, a length of 5, a shank diameter of 0.2625, a head diameter of 0.531, and a bright finish.  
 C = oval countersunk head  
 F = flat head  
 B = bright  
 Z = zinc coated

F 1667 SPRDC <sup>A</sup>					F 1667 SPRDF <sup>A</sup>			
Dash No.	S	L	D	H	Dash No.	L	D	H
01	40d	5	0.2625	0.531	01	8	0.312	0.625
02	50d	5½	0.283	0.562	02	8	0.312	0.750
03	60d	6	0.283	0.562	03	9	0.312	0.750
04	...	7	0.312	0.625	04	10	0.312	0.750
...	...	...	...	...	05	8	0.375	0.750

<sup>A</sup>All dimensions are given in inches.

TABLE 56 Type III, Style 4—Barge and Boat Spikes<sup>A</sup>

NOTE—Wrought iron, hot rolled steel rod or steel wire, square, diamond or oval head, chisel point, bright finish or zinc coated, as specified.

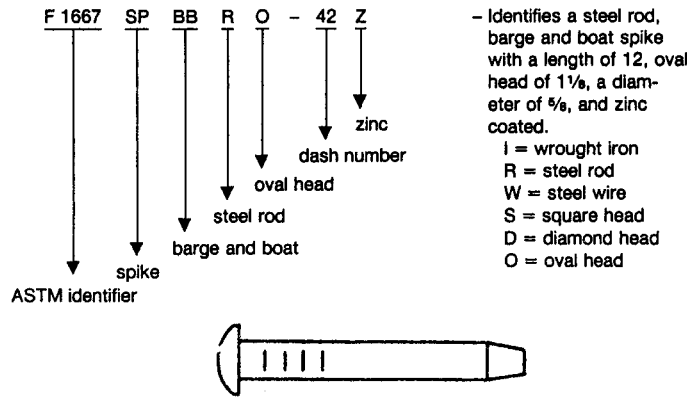

F 1667 SPBB

Dash No.	D-Square	H	L	Dash No.	D-Square	H	L
01	1/4	17/32	3	26	7/16	13/16	8
02	1/4	17/32	3 1/2	27	7/16	13/16	9
03	1/4	17/32	4	28	7/16	13/16	10
04	1/4	17/32	5	29	7/16	13/16	11
05	1/4	17/32	6	30	7/16	13/16	12
06	1/4	17/32	7	31	1/2	1	6
07	1/4	17/32	8	32	1/2	1	7
08	5/16	19/32	3 1/2	33	1/2	1	8
09	5/16	19/32	4	34	1/2	1	9
10	5/16	19/32	5	35	1/2	1	10
11	5/16	19/32	6	36	1/2	1	11
12	5/16	19/32	7	37	1/2	1	12
13	5/16	19/32	8	38	5/8	1 1/8	8
14	3/8	1 1/16	3	39	5/8	1 1/8	9
15	3/8	1 1/16	3 1/2	40	5/8	1 1/8	10
16	3/8	1 1/16	4	41	5/8	1 1/8	11
17	3/8	1 1/16	5	42	5/8	1 1/8	12
18	3/8	1 1/16	6	...	...	...	...
19	3/8	1 1/16	7	...	...	...	...
20	3/8	1 1/16	8	...	...	...	...
21	3/8	1 1/16	9	...	...	...	...
22	3/8	1 1/16	10	...	...	...	...
23	3/8	1 1/16	11	...	...	...	...
24	7/16	13/16	6	...	...	...	...
25	7/16	13/16	7	...	...	...	...

<sup>A</sup> All dimensions are given in inches.

TABLE 57 Type IV, Style 1—Fence Staples<sup>A</sup>

NOTE—Steel wire, bright finish or zinc coated, as specified.

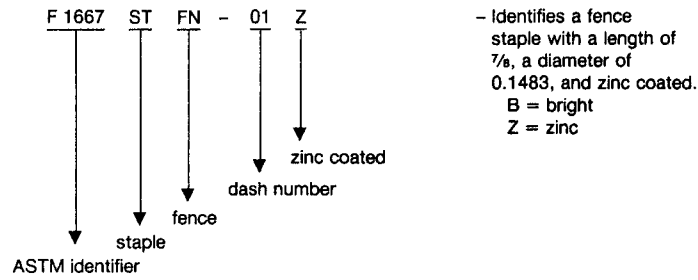

Dash No.	L	D	No./lb
01	7/8	0.1483	120
02	1	0.1483	110
03	1 1/8	0.1483	97
04	1 1/4	0.1483	87
05	1 1/2	0.1483	72
06	1 3/4	0.1483	61

<sup>A</sup> All dimensions are given in inches.

TABLE 58 Type IV, Style 2—Poultry Netting Staples<sup>A</sup>

NOTE—Steel wire, zinc coated.

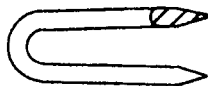
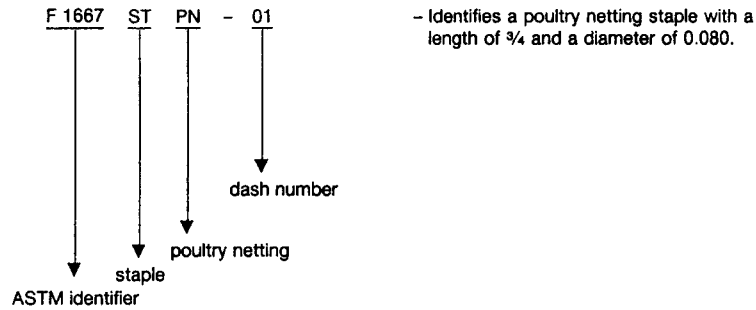

Dash No.	L	D	No./lb
01	3/4	0.080	500

<sup>A</sup> All dimensions are given in inches.

TABLE 59 Type IV, Style 3—Flat Top Crown Staples<sup>A</sup>

NOTE—Steel wire, aluminum alloy wire, bright finish, zinc coated, cement coated or chemically etched, as specified. (For use in power tools for fastening wood and other materials to wood.)

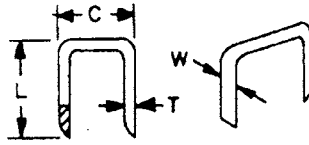
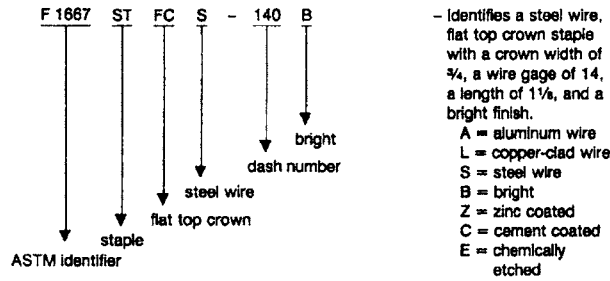

F 1667 STFC								
Dash No.	C	G <sup>#</sup>	L	Dash No.	C	G <sup>#</sup>	L	
01	3/16	18	3/8	51	7/16	14	1 1/2	
02	3/16	18	1/2	52	7/16	14	1 3/8	
03	3/16	18	5/8	53	7/16	14	1 3/4	
04	3/16	18	3/4	54	7/16	14	1 7/8	
05	3/16	18	7/8	55	7/16	14	2	
06	3/16	18	1	58	7/16	14	2 1/4	
07	3/16	18	1 1/8	57	7/16	14	2 1/2	
08	3/16	18	1 1/4	58	7/16	15	3/8	
09	3/8	14	3/8	59	7/16	15	1/2	
10	3/8	14	1/2	60	7/16	15	5/8	
11	3/8	14	5/8	61	7/16	15	3/4	
12	3/8	14	3/4	62	7/16	15	7/8	
13	3/8	14	7/8	63	7/16	15	1	
14	3/8	14	1 1/8	64	7/16	15	1 1/8	
15	3/8	14	1 1/4	65	7/16	15	1 1/4	
16	3/8	14	1 3/8	66	7/16	15	1 3/8	
17	3/8	14	1 1/2	67	7/16	15	1 1/2	
18	3/8	14	1 5/8	68	7/16	15	1 5/8	
19	3/8	14	1 3/4	69	7/16	15	1 3/4	
20	3/8	16	1 3/4	70	7/16	15	1 7/8	
21	3/8	16	1/2	71	7/16	15	2	
22	3/8	16	5/8	72	7/16	15	2 1/4	
23	3/8	16	3/4	73	7/16	15	2 1/2	
24	3/8	16	7/8	74	7/16	16	3/8	
25	3/8	16	1 1/8	75	7/16	16	1/2	
26	3/8	16	1 1/4	76	7/16	16	5/8	
27	3/8	16	1 3/8	77	7/16	16	3/4	
28	3/8	16	1 1/2	78	7/16	16	7/8	
29	3/8	16	1 5/8	79	7/16	16	1	
30	3/8	16	1 3/4	80	7/16	16	1 1/8	
31	3/8	18	3/8	81	7/16	16	1 1/4	
32	3/8	18	1/2	82	7/16	16	1 3/8	
33	3/8	18	5/8	83	7/16	16	1 1/2	
34	3/8	18	3/4	84	7/16	16	1 5/8	
35	3/8	18	7/8	85	7/16	16	1 3/4	
36	3/8	18	1 1/8	86	7/16	16	1 7/8	
37	3/8	18	1 1/4	87	7/16	16	2	
38	3/8	18	1 1/4	88	7/16	16	2 1/4	
39	3/8	18	1 1/2	89	7/16	16	2 1/2	
40	3/8	18	1 5/8	90	1/2	14	1/2	
41	3/8	18	1 3/4	91	1/2	14	5/8	
42	7/16	14	3/8	92	1/2	14	3/4	
43	7/16	14	1/2	93	1/2	14	7/8	
44	7/16	14	5/8	94	1/2	14	1	
45	7/16	14	3/4	95	1/2	14	1 1/8	
46	7/16	14	7/8	96	1/2	14	1 1/4	
47	7/16	14	1	97	1/2	14	1 3/8	
48	7/16	14	1 1/8	98	1/2	14	1 1/2	
49	7/16	14	1 1/4	99	1/2	14	1 5/8	
50	7/16	14	1 3/8	100	1/2	14	1 3/4	



F 1667 STFC							
Dash No.	C	G <sup>a</sup>	L	Dash No.	C	G <sup>a</sup>	L
101	1/2	14	1 7/8	164	7/8	14	7/8
102	1/2	14	2	165	7/8	14	1
103	1/2	14	2 1/4	166	7/8	14	1 1/8
104	1/2	14	2 1/2	167	7/8	14	1 1/4
105	1/2	15	1/2	168	7/8	14	1 3/8
106	1/2	15	5/8	169	7/8	14	1 1/2
107	1/2	15	3/4	170	7/8	14	1 5/8
108	1/2	15	7/8	171	7/8	14	1 3/4
109	1/2	15	1	172	7/8	14	1 7/8
110	1/2	15	1 1/8	173	7/8	14	2
111	1/2	15	1 1/4	174	7/8	18	1/2
112	1/2	15	1 3/8	175	7/8	18	5/8
113	1/2	15	1 1/2	176	7/8	18	3/4
114	1/2	15	1 5/8	177	7/8	18	7/8
115	1/2	15	1 3/4	178	7/8	18	1
116	1/2	15	1 7/8	179	7/8	18	1 1/8
117	1/2	15	2	180	7/8	18	1 1/4
118	1/2	15	2 1/4	181	7/8	18	1 3/8
119	1/2	15	2 1/2	182	7/8	18	1 1/2
120	1/2	16	1/2	183	7/8	18	1 3/8
121	1/2	16	5/8	184	7/8	18	1 1/4
122	1/2	16	3/4	185	7/8	18	1 7/8
123	1/2	16	7/8	186	7/8	18	2
124	1/2	16	1	187	1 1/16	14	1/2
125	1/2	16	1 1/8	188	1 1/16	14	5/8
126	1/2	16	1 1/4	189	1 1/16	14	3/4
127	1/2	16	1 3/8	190	1 1/16	14	7/8
128	1/2	16	1 1/2	191	1 1/16	14	1
129	1/2	16	1 5/8	192	1 1/16	14	1 1/8
130	1/2	16	1 3/4	193	1 1/16	14	1 1/4
131	1/2	16	1 7/8	194	1 1/16	14	1 3/8
132	1/2	16	2	195	1 1/16	14	1 1/2
133	1/2	16	2 1/4	196	1 1/16	16	1/2
134	1/2	16	2 1/2	197	1 1/16	16	5/8
135	3/4	14	1/2	198	1 1/16	16	3/4
136	3/4	14	5/8	199	1 1/16	16	7/8
137	3/4	14	3/4	200	1 1/16	16	1
138	3/4	14	7/8	201	1 1/16	16	1 1/8
139	3/4	14	1	202	1 1/16	16	1 1/4
140	3/4	14	1 1/8	203	1 1/16	16	1 3/8
141	3/4	14	1 1/4	204	1 1/16	16	1 1/2
142	3/4	14	1 3/8	205	1	14	1/2
143	3/4	14	1 1/2	206	1	14	5/8
144	3/4	14	1 5/8	207	1	14	3/4
145	3/4	14	1 3/4	208	1	14	7/8
146	3/4	14	1 7/8	209	1	14	1
147	3/4	14	2	210	1	14	1 1/8
148	3/4	16	1/2	211	1	14	1 1/4
149	3/4	16	5/8	212	1	14	1 3/8
150	3/4	16	3/4	213	1	14	1 1/2
151	3/4	16	7/8	214	1	16	1/2
152	3/4	16	1	215	1	18	5/8
153	3/4	16	1 1/8	216	1	18	3/4
154	3/4	16	1 1/4	217	1	18	7/8
155	3/4	18	1 3/8	218	1	18	1
156	3/4	18	1 1/2	219	1	18	1 1/8
157	3/4	16	1 5/8	220	1	16	1 1/4
158	3/4	16	1 3/4	221	1	16	1 3/8
159	3/4	16	1 7/8	222	1	18	1 1/2
160	3/4	16	2	223	1 3/8	12	3/4
161	7/8	14	1/2	224	1 17/32	12	3/4
162	7/8	14	5/8	225	2 1/8	10	1
163	7/8	14	3/4	...	...	...	...

<sup>a</sup> All dimensions are given in inches.

<sup>b</sup> Dimensions and tolerances for gages of flat top crown staples:

	10 Gage		12 Gage		14 Gage		Nominal	15 Gage		16 Gage		18 Gage	
	T	W	T	W	T	W		T	W	T	W	T	W
Nominal	.1250	.1400	.0935	.1120	.0735	.0855		.0673	.073	.0563	.064	.038	.050
Maximum	.1290	.1440	.0975	.1160	.0775	.0895	Maximum	.0731	.076	.0626	.068	.0415	.0532
Minimum	.1210	.1360	.0895	.1080	.0695	.0815	Minimum	.0615	.070	.0500	.060	.0345	.0468
Tolerance	± .0040	.0040	.0040	.0040	.0040	.0040	Tolerance	± .0058	.003	.0063	.004	.0035	.0032

**TABLE 60 Type IV, Style 3—Flat Top Crown Staples<sup>A</sup>**

NOTE—Steel wire, chisel point, tin plated, zinc coated or lacquer finish, as specified, cohered together in strips. (For use in staple tackers or machines.) The number per strip shall be as specified and shall be suitable for use in the make and model of tool specified.

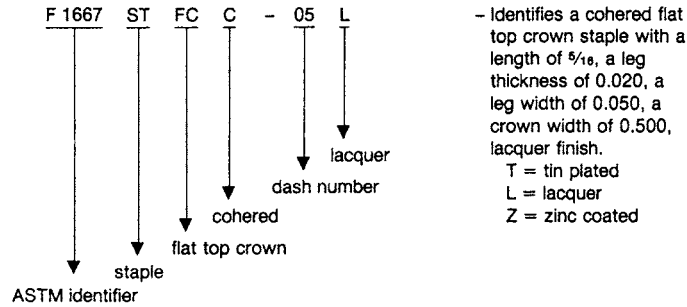

- Identifies a cohered flat top crown staple with a length of 5/16, a leg thickness of 0.020, a leg width of 0.050, a crown width of 0.500, lacquer finish.  
 T = tin plated  
 L = lacquer  
 Z = zinc coated

F 1667 STFC							
Dash No.	L	T × W	C <sup>B</sup>	Dash No.	L	T × W	C <sup>B</sup>
01	3/16	0.020 × 0.030	0.500	10	9/16	0.020 × 0.050	0.437
02	1/4	0.020 × 0.030	0.500	11	3/8	0.030 × 0.050	0.164
03	5/16	0.020 × 0.030	0.500	12	1/2	0.030 × 0.050	0.164
04	1/4	0.020 × 0.050	0.500	13	5/8	0.030 × 0.050	0.164
05	5/16	0.020 × 0.050	0.500	14	3/4	0.030 × 0.050	0.164
06	3/8	0.020 × 0.050	0.500	15	7/8	0.030 × 0.050	0.164
07	1/2	0.020 × 0.050	0.500	16	1	0.030 × 0.050	0.164
08	3/8	0.020 × 0.050	0.437	17	1 1/8	0.030 × 0.050	0.164
09	1/2	0.020 × 0.050	0.437	18	1 1/4	0.030 × 0.050	0.164

<sup>A</sup> All dimensions are given in inches.

<sup>B</sup> Crown width, C, tolerances: 0.500 ± 0.015, 0.437 ± 0.010, and 0.164 ± 0.015.

**TABLE 61 Type IV, Style 4—Round or “V” Crown Staple<sup>A</sup>**

NOTE—Steel wire or copper-clad wire, bright finish, zinc coated, cement coated or chemically etched, as specified. (For use in power tools for fastening wood and other materials to wood.)

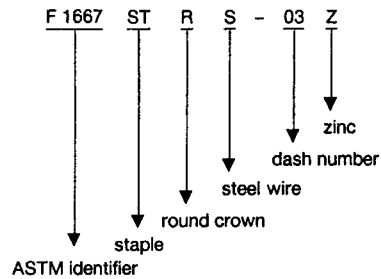

- Identifies a steel round crown staple with a crown width of 0.346, a wire gage of 16, a leg length of 5/8, zinc coated.  
 R = round crown  
 V = V-shaped crown  
 S = steel wire  
 L = copper-clad wire  
 B = bright  
 C = cement coated  
 E = chemical etch  
 Z = zinc coated

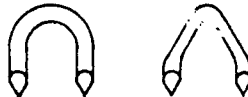

Dash No.	C <sup>B</sup>	G	L	Dash No.	C <sup>B</sup>	G	L
01	0.346	16	1/2	07	0.435	16	1/2
02	0.346	16	9/16	08	0.435	16	9/16
03	0.346	16	5/8	09	0.435	16	5/8
04	0.346	16	3/4	10	0.435	16	3/4
05	0.346	16	7/8	11	0.435	16	7/8
06	0.346	16	1	12	0.435	16	1

<sup>A</sup> All dimensions are given in inches.

<sup>B</sup> Crown width tolerances: +0.015 and -0.000.

**TABLE 62 Type IV, Style 5—Preformed Staples<sup>A</sup>**

NOTE—Steel wire, chisel point, zinc or cement coated, as specified. Copper-clad wire, chisel point, tinned or other plated finish, as specified. (Hand driven.)

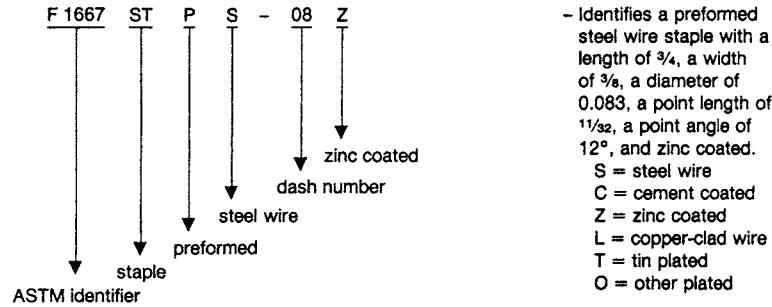

- Identifies a preformed steel wire staple with a length of 3/4, a width of 3/8, a diameter of 0.083, a point length of 1 1/32, a point angle of 12°, and zinc coated.  
 S = steel wire  
 C = cement coated  
 Z = zinc coated  
 L = copper-clad wire  
 T = tin plated  
 O = other plated



Dash No.	L	C	D	Flatten	Point Length	Point Angle, °	No./lb
01	3/8	7/32	0.054	0.040	3/16	13	1920
02	13/32	3/16	0.067	0.048	3/16	12	1380
03	7/16	7/32	0.067	0.048	1/4	12	1250
04	1/2	1/4	0.072	0.057	1/4	12	860
05	9/16	9/32	0.072	0.057	5/16	12	800
06	5/8	5/16	0.072	0.057	5/16	12	670
07	1 1/16	3/4	0.083	0.060	1 1/32	12	540
08	3/4	3/8	0.083	0.060	1 1/32	12	410

<sup>A</sup> All dimensions are given in inches.

**TABLE 63 Type IV, Style 6—Electrical Staples<sup>A</sup>**

NOTE—Insulated or uninsulated, as specified.

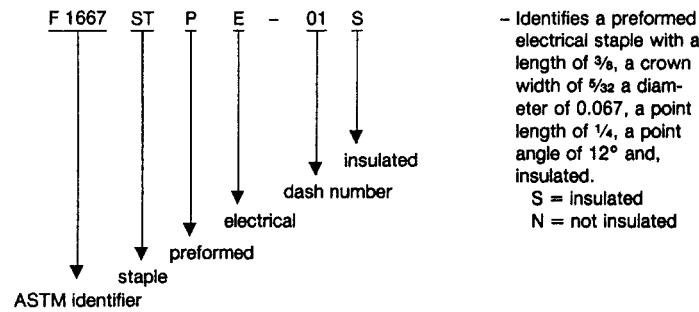

- Identifies a preformed electrical staple with a length of 3/8, a crown width of 5/32 a diameter of 0.067, a point length of 1/4, a point angle of 12° and, insulated.  
 S = insulated  
 N = not insulated

Dash No.	L	C	D	Flatten	Point Length	Point Angle	No./lb
01	3/8	5/32	0.067	0.048	1/4	12	1440
02	1/2	3/16	0.072	0.057	1/4	12	990
03	5/8	1/4	0.072	0.057	5/16	12	740
04	3/4	3/16	0.083	0.060	1 1/32	12	480
05	3/4	1/4	0.083	0.060	1 1/32	12	450
06	7/8	1/4	0.083	0.060	1 1/32	12	400
07	7/8	7/16	0.083	0.060	1 1/32	12	370
08	1	1/2	0.120	0.050 × 0.215	3/8	18	...
09	1 1/4	5/8	0.120	0.050 × 0.215	3/8	18	...

<sup>A</sup> All dimensions are given in inches.

TABLE 64 Type IV, Style 7—Preformed Hoop Staple<sup>A</sup>

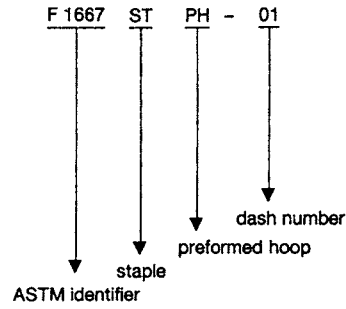

– Identifies a preformed hoop staple with a length of 1/2, a width of 1/2, and a diameter of 0.072.

Dash No.	L	C	D	Flatten	No./lb
01	1/2	1/2	0.072	0.057	720
02	1/2	1/2	0.083	0.060	470
03	5/8	1/2	0.072	0.057	580
04	5/8	1/2	0.083	0.060	430
05	3/4	1/2	0.072	0.057	490
06	3/4	1/2	0.083	0.060	370
07	1/2	5/8	0.072	0.057	670
08	1/2	5/8	0.083	0.060	470
09	5/8	5/8	0.072	0.057	530
10	5/8	5/8	0.083	0.060	400
11	3/4	5/8	0.072	0.057	460
12	3/4	5/8	0.083	0.060	340
13	1/2	3/4	0.072	0.057	580
14	1/2	3/4	0.083	0.060	430
15	1/2	3/4	0.109	0.083	260
16	5/8	3/4	0.072	0.057	490
17	5/8	3/4	0.083	0.060	370
18	5/8	3/4	0.109	0.083	220
19	3/4	3/4	0.072	0.057	430
20	3/4	3/4	0.083	0.060	320
21	3/4	3/4	0.109	0.083	190
22	1	3/4	0.072	0.057	350
23	1	3/4	0.083	0.060	260
24	1	3/4	0.109	0.083	150
25	1/2	7/8	0.072	0.057	530
26	1/2	7/8	0.083	0.060	400
27	5/8	7/8	0.072	0.057	460
28	5/8	7/8	0.083	0.060	340
29	3/4	7/8	0.072	0.057	410
30	3/4	7/8	0.083	0.060	300
31	7/8	7/8	0.072	0.057	360
32	7/8	7/8	0.083	0.060	270
33	5/8	1	0.083	0.060	320
34	5/8	1	0.109	0.083	200
35	3/4	1	0.083	0.060	290
36	3/4	1	0.109	0.083	180
37	7/8	1	0.083	0.060	260
38	7/8	1	0.109	0.083	160
39	1	1	0.083	0.060	240
40	1	1	0.109	0.083	140
41	3/4	1 1/4	0.083	0.060	220
42	3/4	1 1/4	0.109	0.083	130
43	...	1 1/4	0.083	0.060	180
44	1	1 1/4	0.109	0.083	140

<sup>A</sup> All dimensions are given in inches.

**SUPPLEMENTARY REQUIREMENTS**

The following supplementary requirements shall apply when specified in the applicable table or when specified in the order or contract (5.1.7). Details of these supplementary requirements shall be agreed upon in writing between the manufacturer and the purchaser.

**S1. Nail Bending Yield Strength**

S1.1 When specified as a supplementary requirement for nails used for engineered construction, the nail’s average bending yield strengths shall meet, as a minimum, the yield strengths used in determining the lateral design loads tabulated in the AF&PA National Design Specification<sup>3</sup> for Wood Construction, NDS,<sup>3</sup> Part XII: Nails and Spikes.

<sup>3</sup> Available from American Forest and Paper Association (AF&PA), 1111 19th Street, NW, Suite 800, Washington, DC 20036, *National Design Specification*<sup>®</sup>, (NDS<sup>®</sup>), for Wood Construction.

**TABLE S1.1 Low to Medium Carbon Steel Nails and Spikes**

Nominal Diameter, in.	Bending Yield, psi
0.099 ≤ 0.142	100 000
>0.142 ≤ 0.177	90 000
>0.177 ≤ 0.254	80 000
>0.254 ≤ 0.273	70 000
>0.273 ≤ 0.344	60 000
>0.344 ≤ 0.375	45 000

S1.2 The minimum average bending yield strengths used by the NDS<sup>3</sup> as a function of the material and diameter of the nail are given in **Table S1.1** and **Table S1.2**.

S1.3 *Test Method for Yield Strength*—In order to conform with the supplementary requirements of S1, the procedure of Test Method **F 1575** shall be conducted on nail samples.

S1.4 At least five nails from each lot of 100 individual containers shall be examined and tested to determine conformance with this supplementary requirement.

S1.5 When labeled “Engineered Construction Nails, ASTM F 1667,” nails must meet all requirements of F 1667 including Supplementary Requirements.

**TABLE S1.2 Medium Carbon Steel Nails—Hardened**

Nominal Diameter, in.	Bending Yield, psi
0.120 ≤ 0.142	130 000
>0.142 ≤ 0.192	115 000
>0.192 ≤ 0.207	100 000

**SUMMARY OF CHANGES**

Committee F16 has identified the location of selected changes to this standard since the last issue, F 1667 – 03, that may impact the use of this standard. (Approved Nov. 15, 2005.)

(1) **Table 45** was added.

*ASTM International takes no position respecting the validity of any patent rights asserted in connection with any item mentioned in this standard. Users of this standard are expressly advised that determination of the validity of any such patent rights, and the risk of infringement of such rights, are entirely their own responsibility.*

*This standard is subject to revision at any time by the responsible technical committee and must be reviewed every five years and if not revised, either reapproved or withdrawn. Your comments are invited either for revision of this standard or for additional standards and should be addressed to ASTM International Headquarters. Your comments will receive careful consideration at a meeting of the responsible technical committee, which you may attend. If you feel that your comments have not received a fair hearing you should make your views known to the ASTM Committee on Standards, at the address shown below.*

*This standard is copyrighted by ASTM International, 100 Barr Harbor Drive, PO Box C700, West Conshohocken, PA 19428-2959, United States. Individual reprints (single or multiple copies) of this standard may be obtained by contacting ASTM at the above address or at 610-832-9585 (phone), 610-832-9555 (fax), or service@astm.org (e-mail); or through the ASTM website (www.astm.org).*